

# TX-33AK10F Service Manual

---

Specifications

Parts List

Safety

Block  
Diagrams

Service  
Information

Schematic  
Diagrams

Exploded  
View

PCB  
Views

## Service Support

Service and repair of this product is supported by Panasonic's LUCI interface.

This interface provides a link between the TV and a standard PC to allow a number of diagnostic and control functions to be performed.

For more details contact your local Panasonic company.

  
BACK

EXIT

# Service Manual



## Colour Television

### TX-33AK10F

### EURO - 5 Chassis

#### SPECIFICATIONS

<b>Power Source:</b>	220-240V a.c., 50Hz
<b>Power Consumption:</b>	190W
<b>Aerial Impedance:</b>	75Ω unbalanced, Coaxial Type
<b>Standby Power Consumption:</b>	1,9W
<b>Receiving System:</b>	PAL-I, B/G, H, D/K, PAL-525/60 SECAM L/L', B/G, D/K M.NTSC NTSC (AV only)
<b>Receiving Channels:</b>	VHF H1-H2 (ITALY) VHF A-H (ITALY) VHF R3-R5 UHF E21-E69 CATV S1-S10 (M1-M10) CATV S21-S41 (HYPERBAND)
<b>Intermediate Frequency:</b>	Video 38,9MHz, 34MHz Sound 32,9MHz, 33,16MHz, 33,4MHz 40,4MHz, 32,4MHz (A2 STEREO) 33,05MHz, 34,05MHz (NICAM) 32,66MHz, 32,4MHz (CZECH STEREO) 34,47MHz (PAL) 34,5MHz, 34,65MHz (SECAM)
<b>Colour</b>	
<b>Video/Audio Terminals:</b>	
AV1 IN	Video (21 pin) 1V p-p 75Ω Audio (21 pin) 500mV rms 10kΩ RGB (21 pin)
AV1 OUT	Video (21 pin) 1V p-p 75Ω Audio (21 pin) 500mV rms 1kΩ
AV2 IN	Video (21 pin) 1V p-p 75Ω Audio (21 pin) 500mV rms 10kΩ S-Video IN Y: 1V p-p 75Ω (21 pin) C: 0,3V p-p 75Ω
AV2 OUT	Video (21 pin) 1V p-p 75Ω Audio (21 pin) 500mV rms 1kΩ Selectable Output (21 pin)
AV3 IN	S-Video IN Y: 1V p-p 75Ω (4-pin) C: 0,3V p-p 75Ω Audio (RCAx2) 500mV rms 10kΩ Video (RCAx1) 1V p-p 75Ω
AV4 IN	Video (21 pin) 1V p-p 75Ω Audio (21 pin) 500mV rms 10kΩ S-Video IN Y: 1V p-p 75Ω (21 pin) C: 0,3V p-p 75Ω
AV4 OUT	Video (21 pin) 1V p-p 75Ω Audio (21 pin) 500mV rms 1kΩ
<b>Dolby Surround out External Speaker Connections</b>	6 x Dolby Surround Out RCA 2 x Rear 2 x Front
<b>High Voltage:</b>	32kV ± 1kV
<b>Picture Tube:</b>	M79LQM185X05
<b>Audio Output:</b>	2 x 20W Left/Right 14W Centre
(Music Power)	8Ω Impedance
Headphones	8Ω Impedance
<b>Accessories supplied:</b>	Remote Control 2 x R6 (UM3) Batteries
<b>Dimensions:</b>	
Height:	651mm
Width:	790mm
Depth:	555mm
<b>Net Weight:</b>	66kg

Specifications are subject to change without notice.  
Weights and dimensions shown are approximate.

**NOTE:** This Service Manual should be used in conjunction with the EURO-5 technical guide.

#### TECHNISCHE DATEN

<b>Netzspannung:</b>	220-240V a.c., 50Hz
<b>Leistungsaufnahme:</b>	190W
<b>Antennenimpedanz:</b>	75Ω asymmetrisch, Koaxial-Typ
<b>Standby Leistungsaufnahme:</b>	1,9W
<b>Empfangssystem:</b>	PAL-I, B/G, H, D/K, PAL-525/60 SECAM L/L', B/G, D/K M.NTSC NTSC (nur AV Eingang)
<b>Empfangsbereiche:</b>	VHF H1-H2 (ITALY) VHF A-H (ITALY) VHF R3-R5 UHF E21-E69 CATV S1-S10 (M1-M10) CATV S21-S41 (HYPERBAND)
<b>Zwischenfrequenz:</b>	Video 38,9MHz, 34MHz Sound 32,9MHz, 33,16MHz, 33,4MHz 40,4MHz, 32,4MHz (A2 STEREO) 33,05MHz, 34,05MHz (NICAM) 32,66MHz, 32,4MHz (CZECH STEREO) 34,47MHz (PAL) 34,5MHz, 34,65MHz (SECAM)
<b>Colour</b>	
<b>Video/Audio Anschlüsse:</b>	
AV1 EINGANG	Video (21 pin) 1V p-p 75Ω Audio (21 pin) 500mV rms 10kΩ RGB (21 pin)
AV1 AUSGANG	Video (21 pin) 1V p-p 75Ω Audio (21 pin) 500mV rms 1kΩ
AV2 EINGANG	Video (21 pin) 1V p-p 75Ω Audio (21 pin) 500mV rms 10kΩ S-Video IN Y: 1V p-p 75Ω (21 pin) C: 0,3V p-p 75Ω
AV2 AUSGANG	Video (21 pin) 1V p-p 75Ω Audio (21 pin) 500mV rms 1kΩ Wählbarer Ausgang
AV3 EINGANG	S-Video IN Y: 1V p-p 75Ω (4-pin) C: 0,3V p-p 75Ω Audio (RCAx2) 500mV rms 10kΩ Video (RCAx1) 1V p-p 75Ω
AV4 EINGANG	Video (21 pin) 1V p-p 75Ω Audio (21 pin) 500mV rms 10kΩ S-Video IN Y: 1V p-p 75Ω (21 pin) C: 0,3V p-p 75Ω
AV4 AUSGANG	Video (21 pin) 1V p-p 75Ω Audio (21 pin) 500mV rms 1kΩ
<b>Dolby Surround-Ausgang Externe Lautsprecheranschlüsse</b>	6 x Dolby Surround Ausgänge RCA 2 x vorne 2 x hinten
<b>Hochspannung:</b>	32kV ± 1kV
<b>Bildrohre:</b>	M79LQM185X05
<b>Ton Ausgangsleistung:</b>	2 x 20W Links/Rechts 14W Zentraler
(Musikleistung)	8Ω Impedanz
Kopfhörer:	8Ω Impedanz
<b>Mitgel. Zubehör:</b>	Fernbedienung 2 x R6 (UM3) Batterien
<b>Abmessungen:</b>	
Höhe:	651mm
Breite:	790mm
Tiefe:	555mm
<b>Gewicht:</b>	66kg

Änderungen der Technischen Daten vorbehalten.  
Gewichte und Abmessungen sind Näherungsangaben.

**Hinweis:** Bitte verwende Sie das Service Manual zusammen mit dem Technical Guide.

# CONTENTS

SAFETY PRECAUTIONS .....	2
SERVICE HINTS .....	4
SERVICE POSITION .....	5
SELF CHECK .....	6
ADJUSTMENT PROCEDURE .....	7
WAVEFORM PATTERN TABLE .....	8
ALIGNMENT SETTINGS .....	9
BLOCK DIAGRAMS .....	11
PARTS LOCATION .....	15
REPLACEMENT PARTS LIST .....	16
SCHEMATIC DIAGRAMS .....	35
CONDUCTOR VIEWS .....	43

## SAFETY PRECAUTIONS

### GENERAL GUIDE LINES

1. It is advisable to insert an isolation transformer in the a.c. supply before servicing a hot chassis.
2. When servicing, observe the original lead dress in the high voltage circuits. If a short circuit is found, replace all parts which have been overheated or damaged by the short circuit.
3. After servicing, see that all the protective devices such as insulation barriers, insulation papers, shields and isolation R-C combinations are correctly installed.
4. When the receiver is not being used for a long period of time, unplug the power cord from the a.c. outlet.
5. Potentials as high as 33kV are present when this receiver is in operation. Operation of the receiver without the rear cover involves the danger of a shock hazard from the receiver power supply. Servicing should not be attempted by anyone who is not familiar with the precautions necessary when working on high voltage equipment. Always discharge the anode of the tube.
6. After servicing make the following leakage current checks to prevent the customer from being exposed to shock hazard.

### LEAKAGE CURRENT COLD CHECK

1. Unplug the a.c. cord and connect a jumper between the two prongs of the plug.
2. Turn on the receiver's power switch.
3. Measure the resistance value with an ohmmeter, between the jumpered a.c. plug and each exposed metallic cabinet part on the receiver, such as screw heads, aerials, connectors, control shafts etc. When the exposed metallic part has a return path to the chassis the reading should be between 4M ohm and 20M ohm. When the exposed metal does not have a return path to the chassis the reading must be infinite.

# INHALT

SICHERHEITSVORKEHRUNGEN .....	2
SERVICE HINWEISE .....	4
SERVICEPOSITION .....	5
SELBSTDIAGNOSE .....	6
ABGLEICH .....	7
SIGNAL TABELLE .....	8
ABGLEICHTABELLE .....	10
SCHALTBILD BLOCK .....	11
EXPLOSIONSZEICHNUNG .....	15
ERSATZTEILLISTE .....	16
SCHALTBILD SCHEMA .....	35
ANSICHT DER LEITERBAHNEN .....	43

## SICHERHEITSVORKEHRUNGEN

### ALLGEMEINE RICHTLINIEN

1. Es ist empfehlenswert einen Trenntransformator in die Stromversorgung zu schalten, bevor Reparaturen an einem Gerät vorgenommen werden, dessen Chassis unter Spannung steht.
2. Bei der Durchführung von Servicearbeiten dürfen die ursprünglichen Kabelanschlüsse nicht vertauscht werden. Dies gilt insbesondere für die Anschlüsse im Hochspannungsteil. Hat sich ein Kurzschluß ereignet, dann sind alle Teile, an denen Spuren von Überhitzung sichtbar sind, auszuwechseln.
3. Nach Beenden der Servicearbeiten ist sicherzustellen, daß alle Sicherheitsvorrichtungen, wie Isolationsstege, Isolationspapiere, Abschirmungen und Isolations -R-C- Glieder wieder richtig eingesetzt sind.
4. Wenn der Fernseher während längerer Zeit nicht in Betrieb gesetzt wird, sollte der Netzstecker aus der Netzsteckdose gezogen werden.
5. Im Betrieb sind Spannungen bis zu 33kV in diesem Gerät vorhanden. Die Inbetriebnahme des Fernsehers ohne aufgesetzte Rückwand bringt die Gefahr eines elektrischen Schlages von der Fernseher - Stromversorgung mit sich. Servicearbeiten sollten daher auch nie durch Personen versucht werden, die nicht in vollem Umfang mit den Sicherheitsvorkehrungen beim Umgang mit Hochspannungsgeräten vertraut sind. Vor der Handhabung mit der Bildröhre ist die Anode der Bildröhre immer an dem Empfängerchassis zu entladen.
6. Nach Beenden der Servicearbeiten sind die folgenden Kriechstrom-Prüfungen durchzuführen, um den Kunden vor der Gefahr eines elektrischen Schlages zu schützen.

### MESSUNG DES ISOLATIONSWIDERSTANDES IM ABGESCHALTETEN ZUSTAND

1. Den Netzstecker aus der Netzsteckdose ziehen und die beiden Steckerstifte kurzschließen.
2. Den Geräteschalter des Fernsehgerätes einschalten.
3. Mit einem Ohmmeter den Widerstandswert zwischen dem überbrückten Netzkabelstecker und jedem zugänglichen Metallteil am Gehäuse des Fernsehgerätes, wie Schraubenköpfe, Antennen, Achsen der Regler, Griffassungen usw. messen. Wenn ein zugängliches Metallteil keine Rückleitung zum Chassis hat, muß die Anzeige unendlich betragen.

### LEAKAGE CURRENT HOT CHECK

1. Plug the a.c. cord directly into the a.c. outlet. Do not use an isolation transformer for this check.
2. Connect a  $2k\Omega$  10W resistor in series with an exposed metallic part on the receiver and an earth, such as a water pipe.
3. Use an a.c. voltmeter with high impedance to measure the potential across the resistor.
4. Check each exposed metallic part and check the voltage at each point.
5. Reverse the a.c. plug at the outlet and repeat each of the above measurements.
6. The potential at any point should not exceed 1,4 V rms. In case a measurement is outside the limits specified, there is a possibility of a shock hazard, and the receiver should be repaired and rechecked before it is returned to the customer.

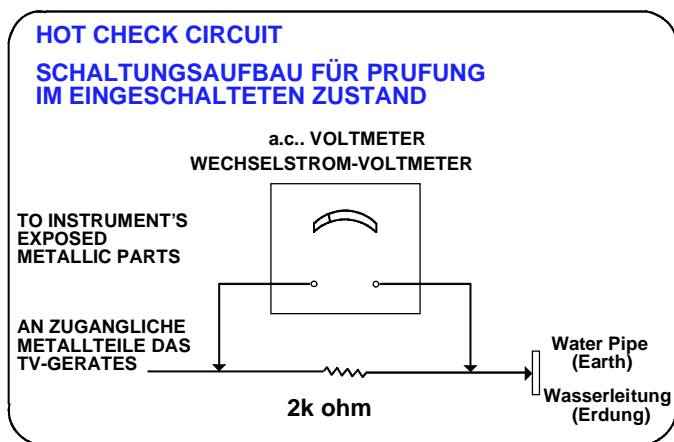

Fig.1.  
Abb.1.

### X-RADIATION WARNING

1. The potential sources of X-Radiation in TV sets are the high voltage section and the picture tube.
2. When using a picture tube test jig for service, ensure that the jig is capable of handling 33kV without causing X-Radiation.

**NOTE : It is important to use an accurate periodically calibrated high voltage meter.**

1. Set the brightness to minimum.
2. Measure the high voltage. The meter should indicate  $32kV \pm 1kV$ . If the meter indication is out of tolerance, immediate service and correction is required to prevent the possibility of premature component failure.
3. To prevent any X-Radiation possibility, it is essential to use the specified tube.

### MESSUNG DES KRIECHSTROMS IM EINGESCHALTETEN ZUSTAND

1. Den Netzstecker direkt in eine Netzsteckdose stecken. Für diese Messung keinen Trenntransformator verwenden.
2. Einen  $2k\Omega$  / 10W-Widerstand in Serie mit einem von außen zugänglichen Metallteil am Fernsehgerät und einer guten, Erdung z.B Wasserleitung, anschließen.
3. Ein Wechselstrom-Voltmeter mit einem Meßbereich von 1000 Ohm.Volt oder größer verwenden, um die Spannung über den Widerstand zu messen.
4. Jedes zugängliche Metallteil prüfen, und an jedem Punkt dies Spannung messen.
5. Den Netzstecker umgekehrt in die Steckdose stecken und jede der obigen Messungen wiederholen.
6. Die Spannung darf an keinem der Punkte 1,4V eff. überschreiten. Wird dieser Wert nicht eingehalten, besteht die Gefahr eines elektrischen Schlags, und das Fernsehgerät sollte daher repariert und nachgeprüft werden, bevor es an den Kunden zurückgegeben wird.

### RÖNTGENSTRAHLUNG ACHTUNG :

1. Potentielle Quellen von Röntgenstrahlung in Fernsehgeräten sind das Hochspannungsteil und die Bildröhre.
2. Bei Verwendung eines Bildröhren-Prüfgerätes für den Service ist sicherzustellen, daß es für die Belastung von 33kV geeignet ist, ohne daß eine Röntgenstrahlung verursacht wird.

**ANMERKUNG : Es ist wichtig, daß ein präzises, regelmäßig geprüfetes Voltmeter verwendet wird.**

1. Helligkeit auf Minimum stellen.
2. Die Hochspannung messen. Die Anzeige des Instrumentes sollte  $32kV \pm 1kV$ . Falls die Anzeige diese Toleranzgrenzen überschreitet, ist die sofortige Behebung nötig, um die Möglichkeit vorzeitigen Komponentenausfalls zu verhüten.
3. Um die Möglichkeit von Röntgenstrahlung zu begrenzen, ist es wichtig, daß nur die vorgeschriebene Bildröhre verwendet wird.



## SERVICE HINTS

### HOW TO REMOVE THE REAR COVER

1. Remove the 10 screws as shown in Fig.2.

## SERVICE HINWEISE

### ENTFERNEN DER GERÄTERÜCKWAND

1. Die 10 Schrauben entfernen, siehe Abb.2.

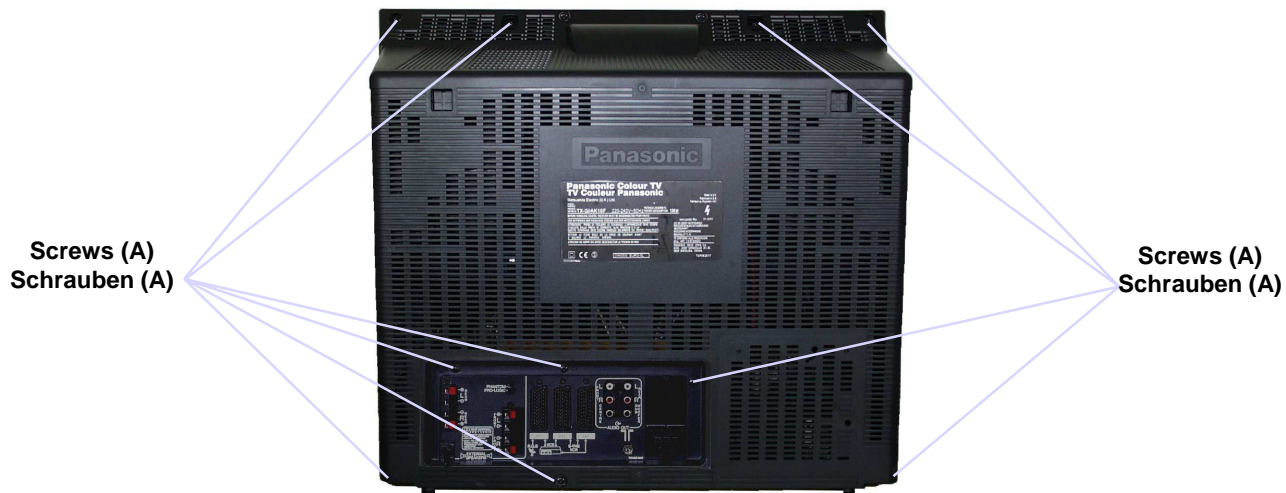

Screws (A)  
Schrauben (A)

Screws (A)  
Schrauben (A)

Fig.2.  
Abb.2.

## LOCATION OF CONTROLS

## LAGE DER EINSTELLREGLER

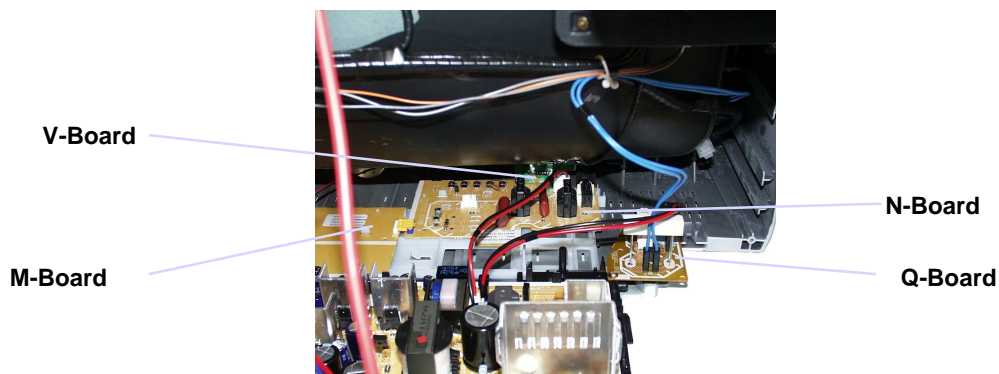
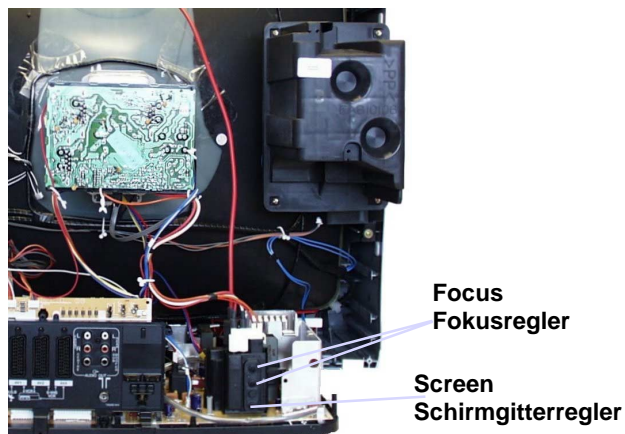
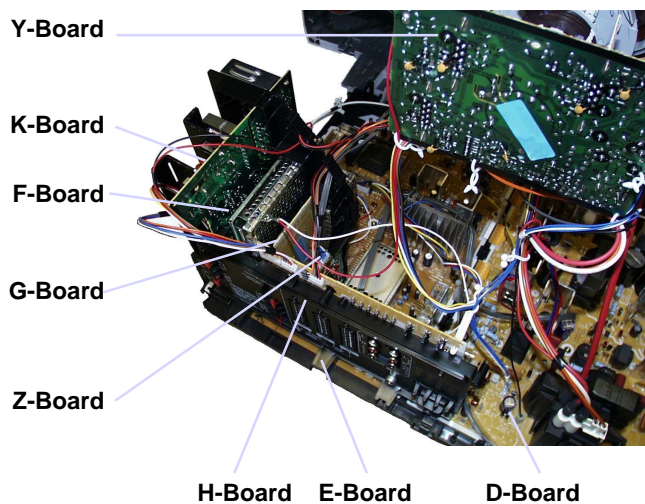

## How to move the chassis into Service position

1. Remove the bead clamber from the mains lead and affix, using back cover screw, into top right-hand cabinet rib (A), shown in Fig.3.
2. Remove 2 screws (B), as shown in Fig.4, and remove speaker assembly.
3. Hold and lift the rear of the chassis and gently pull the chassis toward you, as shown in Fig.3.
4. Release the respective wiring clips and rotate the chassis vertically through 90°, anti-clockwise.
5. Locate the base of the chassis frame into location (C), shown in Fig.5 / Fig.7.
6. Clip the chassis frame onto the bead clamber, shown in Fig.5 / Fig.6.
7. After servicing replace the bead clamber and speaker, and ensure all wiring is returned to its original position before returning the receiver to the customer.

## Serviceposition für das Chassis

1. Entfernen Sie den Kabelbinder von der Netzleitung und befestigen Sie ihn mit einer Rückwandschraube am Gehäuse an der Position (A). (Abb.3.)
2. Nach dem Lösen der zwei Schrauben (B) kann der rechte Lautsprecher (Abb.4) ausgebaut werden.
3. Das Chassis am hinteren Ende anheben und vorsichtig herausziehen (Abb.3).
4. Die Kabelhalter werden gelöst und das Chassis gegen den Uhrzeigersinn um 90° gedreht.
5. Das untere Ende des Chassis wird in die Halterung (C) gesteckt (Abb.5 / Abb.7).
6. Das obere Ende des Chassis wird in den Kabelbinder eingehängt (Abb.5 / Abb.6).
7. Nach der Reparatur wird der Lautsprecher wieder eingebaut, der Kabelbinder entfernt und alle Kabelbäume auf die Originalposition in die Halterungen eingesetzt.

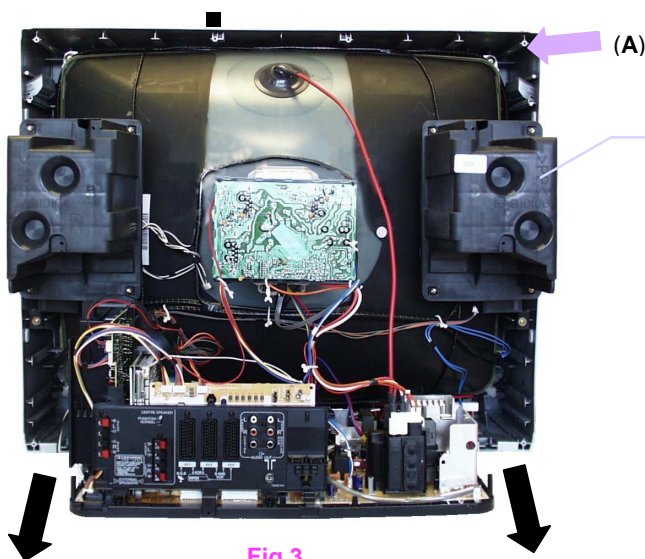

Fig.3.  
Abb.3.



Screws  
Schrauben  
(B)

Fig.4.  
Abb.4.

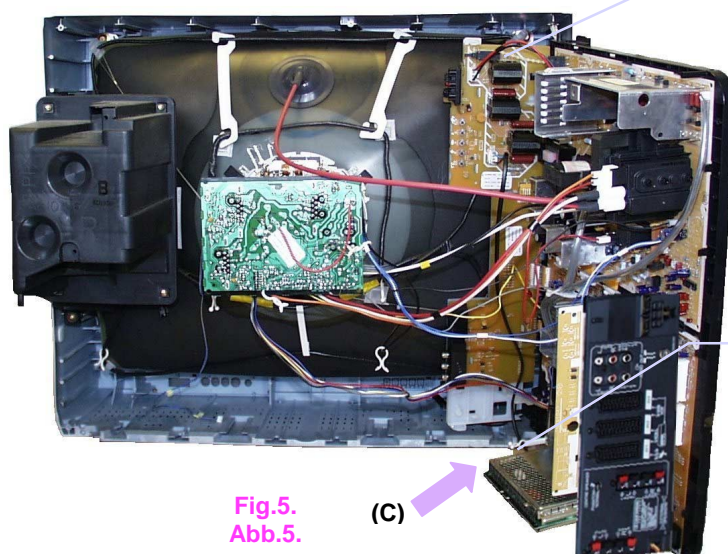

Fig.5.  
Abb.5.

(C)

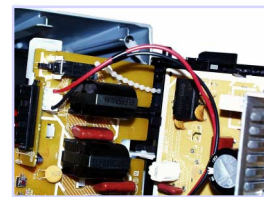

Fig.6.  
Abb.6.

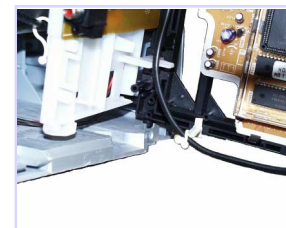

Fig.7.  
Abb.7.

## SELF CHECK

1. Self-check is used to automatically check the bus lines and hexadecimal code of the TV set.
2. To get into the Self-Check mode press the down **(-V)** button on the customer controls at the front of the set, at the same time pressing the **STATUS** button on the remote control, and the screen will show :-

VPC	O.K		
TUN	O.K	PCB	O.K.
E2	O.K	Cab	O.K.
DPL	O.K.		
CIP1	O.K	Sum	Factory use only
CIP2	O.K		Nur für Herstellung
VP	O.K		
DFU	O.K		
COL	--		
PIP	--		
DIS	O.K		
OPTION 1	B9		
OPTION 2	3C		
OPTION 3	1F		
OPTION 4	67		
OPTION 5	FB		
OPTION 6	63		

## SELBSTDIAGNOSE

1. Die Selbstdiagnose dient zum automatischen Prüfen der Bus-Leitungen sowie des Hexadezimalcodes des FS-Geräts. Zum Umschalten auf Selbstdiagnose zunächst die Taste "**STATUS**" auf der Fernbedienung und gleichzeitig die-Taste am Bedienteil des FS-Gerätes drücken **(-V)**, auf dem Bildschirm erscheint hierauf :-
2. Nach der Selbstdiagnose wird das Gerät automatisch auf sämtliche werksseitigen Standardeinstellungen zurückgesetzt :-

If the CCU ports have been checked and found to be incorrect or not located then " - - " will appear in place of "O.K.". Wenn der Hauptprozessor (CCU) an den Anschlüssen einen Fehler erkennt, oder der entsprechende Anschluss nicht belegt ist, zeigt die entsprechende Position " - - " anstelle von OK an.

### Service Aids

To aid in the service of our current chassis there are a number of Service Aids which have been made available.

- **LUCI** interface kit (**L**inked **U**tility **C**omputer **I**nterface)  
Part number: TZS6EZ002  
This contains interface and cables for connecting TV service connector and a PC as well as diagnostic software. As new models are introduced upgrade software will become available.
- **VICI** (**V**isual **I**nteractive **C**omputer **I**nformation)  
These C.D.'s contain multimedia documentation providing quick access to service information.  
Part No. TZS7EZ006, TZS7EZ005 & TZS8EZ001  
1. Service Manuals  
2. Instruction Books  
3. Technical Information
- **TASMIN** (**T**echnically **A**dvanced **S**ystem for **M**ultimedia **I**nteractive **N**otes)  
As well as providing a first step towards more interactive training this product also achieves quick access to Technical Information.

**NOTE:** This TV also has the option of using a Memory Pack which enables you to copy the preset TV channels into the Memory Pack and then download them onto this or any other EURO-5 TV set.

### Service-Hilfen

Zur Unterstützung der Servicearbeiten stehen weitere Hilfsmittel zur Verfügung.

- **LUCI** interface kit (PC-unterstütztes Diagnosesystem)  
Bestell-Nr.: TZS6EZ002  
Es beinhaltet ein Interface, die Anschlusskabel zum FS-Gerät und die Diagnose-Software. Bei Einführung von neuen Modellen ist ein Update der Software jederzeit möglich.
- **VICI** (Interaktive CD-ROM) mit schnellem Zugriff auf Serviceinformationen.  
Bestell-Nr.:TZS7EZ006, TZS7EZ005 & TZS8EZ001  
1. Service Manuals  
2. Bedienungsanleitungen  
3. Technical Information
- **TASMIN** (Technisch erweitertes System für interaktive Multimedia-Hinweise und Notizen)  
Genauso wie dieses Produkt einen ersten Schritt in Richtung erweitertes interaktives Training bereitstellt, ermöglicht es einen noch schnelleren Zugang zu technischen Informationen.

**HINWEIS:** Dieses FS-Gerät bietet auch die Möglichkeit eines Memory Pack, mit dem Sie die gewählten Fernsehkanäle abspeichern und auf jedes beliebige EURO-5 FS-Gerät umkopieren können.

## ADJUSTMENT PROCEDURE

Item/Preparation	Adjustments																																																				
<p style="text-align: center;"><b>+B SET-UP</b></p> <ol style="list-style-type: none"> <li>1. Receive a Greyscale signal.</li> <li>2. Set the controls:-            Brightness      Minimum             Contrast      Minimum             Volume      Minimum</li> </ol>	<ol style="list-style-type: none"> <li>1. Confirm the following voltages.</li> </ol> <table border="0"> <thead> <tr> <th colspan="2">D-Board</th> <th colspan="2">E-Board</th> </tr> </thead> <tbody> <tr> <td>D3</td> <td>PIN5 147V ± 3V</td> <td>U8A</td> <td>E19-PIN8 8V ± 0,5V</td> </tr> <tr> <td>D12</td> <td>PIN5 5V ± 0,3V</td> <td>U9</td> <td>IC3801-PIN3 9V ± 0,5V</td> </tr> <tr> <td>D13</td> <td>PIN1 40V ± 4V</td> <td>U12</td> <td>E22-PIN8 12V ± 0,5V</td> </tr> <tr> <td>D3</td> <td>PIN4 230V ± 10V</td> <td>STD5V</td> <td>E26-PIN4 5V ± 0,5V</td> </tr> <tr> <td>D3</td> <td>PIN4 205V ± 10V</td> <td>U15</td> <td>E23-PIN8 15V ± 1V</td> </tr> <tr> <td>D3</td> <td>PIN4 190V ± 10V</td> <td>U15</td> <td>E23-PIN9 -15V ± 1V</td> </tr> <tr> <td>D3</td> <td>PIN4 190V ± 10V</td> <td>U33</td> <td>E22-PIN10 33V ± 4V</td> </tr> <tr> <td>D14</td> <td>PIN5 5V ± 0,5V</td> <td>U40</td> <td>E24-PIN1 40V ± 3V</td> </tr> <tr> <td>D12</td> <td>PIN7 15V ± 2V</td> <td>U5B</td> <td>E19-PIN5 5V ± 0,5V</td> </tr> <tr> <td>D12</td> <td>PIN9 15V ± 2V</td> <td></td> <td></td> </tr> <tr> <td>D11</td> <td>PIN8 12V ± 2V</td> <td></td> <td></td> </tr> <tr> <td>D11</td> <td>PIN10 33V ± 3V</td> <td></td> <td></td> </tr> </tbody> </table>	D-Board		E-Board		D3	PIN5 147V ± 3V	U8A	E19-PIN8 8V ± 0,5V	D12	PIN5 5V ± 0,3V	U9	IC3801-PIN3 9V ± 0,5V	D13	PIN1 40V ± 4V	U12	E22-PIN8 12V ± 0,5V	D3	PIN4 230V ± 10V	STD5V	E26-PIN4 5V ± 0,5V	D3	PIN4 205V ± 10V	U15	E23-PIN8 15V ± 1V	D3	PIN4 190V ± 10V	U15	E23-PIN9 -15V ± 1V	D3	PIN4 190V ± 10V	U33	E22-PIN10 33V ± 4V	D14	PIN5 5V ± 0,5V	U40	E24-PIN1 40V ± 3V	D12	PIN7 15V ± 2V	U5B	E19-PIN5 5V ± 0,5V	D12	PIN9 15V ± 2V			D11	PIN8 12V ± 2V			D11	PIN10 33V ± 3V		
D-Board		E-Board																																																			
D3	PIN5 147V ± 3V	U8A	E19-PIN8 8V ± 0,5V																																																		
D12	PIN5 5V ± 0,3V	U9	IC3801-PIN3 9V ± 0,5V																																																		
D13	PIN1 40V ± 4V	U12	E22-PIN8 12V ± 0,5V																																																		
D3	PIN4 230V ± 10V	STD5V	E26-PIN4 5V ± 0,5V																																																		
D3	PIN4 205V ± 10V	U15	E23-PIN8 15V ± 1V																																																		
D3	PIN4 190V ± 10V	U15	E23-PIN9 -15V ± 1V																																																		
D3	PIN4 190V ± 10V	U33	E22-PIN10 33V ± 4V																																																		
D14	PIN5 5V ± 0,5V	U40	E24-PIN1 40V ± 3V																																																		
D12	PIN7 15V ± 2V	U5B	E19-PIN5 5V ± 0,5V																																																		
D12	PIN9 15V ± 2V																																																				
D11	PIN8 12V ± 2V																																																				
D11	PIN10 33V ± 3V																																																				
<p style="text-align: center;"><b>Cut-Off</b></p> <ol style="list-style-type: none"> <li>1. Receive a Greyscale signal.</li> <li>2. Degauss the tube externally.</li> <li>3. Set the TV into Service Mode 1.</li> <li>4. Select Cutoff mode.</li> </ol>	<p>Adjust the screen VR until the display shows "O.K."</p>																																																				

## ABGLEICH

Vorbereitungen	Abgleich																																																				
<p style="text-align: center;"><b>+B - Abgleich</b></p> <ol style="list-style-type: none"> <li>1. Testbild empfangen.</li> <li>2. Helligkeit auf Minimum             Kontrast auf Minimum             Lautstärke      Minimum</li> </ol>	<ol style="list-style-type: none"> <li>1. Folgende Spannungen sind zu überprüfen.</li> </ol> <table border="0"> <thead> <tr> <th colspan="2">D-Board</th> <th colspan="2">E-Board</th> </tr> </thead> <tbody> <tr> <td>D3</td> <td>PIN5 147V ± 3V</td> <td>U8A</td> <td>E19-PIN8 8V ± 0,5V</td> </tr> <tr> <td>D12</td> <td>PIN5 5V ± 0,3V</td> <td>U9</td> <td>IC3801-PIN3 9V ± 0,5V</td> </tr> <tr> <td>D13</td> <td>PIN1 40V ± 4V</td> <td>U12</td> <td>E22-PIN8 12V ± 0,5V</td> </tr> <tr> <td>D3</td> <td>PIN4 230V ± 10V</td> <td>STD5V</td> <td>E26-PIN4 5V ± 0,5V</td> </tr> <tr> <td>D3</td> <td>PIN4 205V ± 10V</td> <td>U15</td> <td>E23-PIN8 15V ± 1V</td> </tr> <tr> <td>D3</td> <td>PIN4 190V ± 10V</td> <td>U15</td> <td>E23-PIN9 -15V ± 1V</td> </tr> <tr> <td>D3</td> <td>PIN4 190V ± 10V</td> <td>U33</td> <td>E22-PIN10 33V ± 4V</td> </tr> <tr> <td>D14</td> <td>PIN5 5V ± 0,5V</td> <td>U40</td> <td>E24-PIN1 40V ± 3V</td> </tr> <tr> <td>D12</td> <td>PIN7 15V ± 2V</td> <td>U5B</td> <td>E19-PIN5 5V ± 0,5V</td> </tr> <tr> <td>D12</td> <td>PIN9 15V ± 2V</td> <td></td> <td></td> </tr> <tr> <td>D11</td> <td>PIN8 12V ± 2V</td> <td></td> <td></td> </tr> <tr> <td>D11</td> <td>PIN10 33V ± 3V</td> <td></td> <td></td> </tr> </tbody> </table>	D-Board		E-Board		D3	PIN5 147V ± 3V	U8A	E19-PIN8 8V ± 0,5V	D12	PIN5 5V ± 0,3V	U9	IC3801-PIN3 9V ± 0,5V	D13	PIN1 40V ± 4V	U12	E22-PIN8 12V ± 0,5V	D3	PIN4 230V ± 10V	STD5V	E26-PIN4 5V ± 0,5V	D3	PIN4 205V ± 10V	U15	E23-PIN8 15V ± 1V	D3	PIN4 190V ± 10V	U15	E23-PIN9 -15V ± 1V	D3	PIN4 190V ± 10V	U33	E22-PIN10 33V ± 4V	D14	PIN5 5V ± 0,5V	U40	E24-PIN1 40V ± 3V	D12	PIN7 15V ± 2V	U5B	E19-PIN5 5V ± 0,5V	D12	PIN9 15V ± 2V			D11	PIN8 12V ± 2V			D11	PIN10 33V ± 3V		
D-Board		E-Board																																																			
D3	PIN5 147V ± 3V	U8A	E19-PIN8 8V ± 0,5V																																																		
D12	PIN5 5V ± 0,3V	U9	IC3801-PIN3 9V ± 0,5V																																																		
D13	PIN1 40V ± 4V	U12	E22-PIN8 12V ± 0,5V																																																		
D3	PIN4 230V ± 10V	STD5V	E26-PIN4 5V ± 0,5V																																																		
D3	PIN4 205V ± 10V	U15	E23-PIN8 15V ± 1V																																																		
D3	PIN4 190V ± 10V	U15	E23-PIN9 -15V ± 1V																																																		
D3	PIN4 190V ± 10V	U33	E22-PIN10 33V ± 4V																																																		
D14	PIN5 5V ± 0,5V	U40	E24-PIN1 40V ± 3V																																																		
D12	PIN7 15V ± 2V	U5B	E19-PIN5 5V ± 0,5V																																																		
D12	PIN9 15V ± 2V																																																				
D11	PIN8 12V ± 2V																																																				
D11	PIN10 33V ± 3V																																																				
<p style="text-align: center;"><b>Cut-Off</b></p> <ol style="list-style-type: none"> <li>1. Testbild empfangen.</li> <li>2. Bildröhre entmagnetisieren.</li> <li>3. Service-Mode 1 anwählen.</li> <li>4. Im Service-Mode den Abgleichpunkt Cutoff-Mode wählen .</li> </ol>	<p>Bis OK auf dem Bildschirm erscheint. Den Wert abspeichern.</p>																																																				



## WAVEFORM PATTERN TABLE SIGNAL TABELLE

**NOTE:** All waveforms have been taken using a standard colour bar pattern.

**HINWEIS:** Alle oszillogramme wurden unter Verwendung des Standard Farbbalken Testbildes aufgenommen.

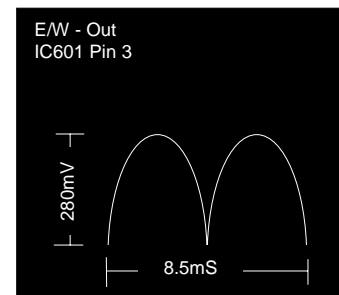
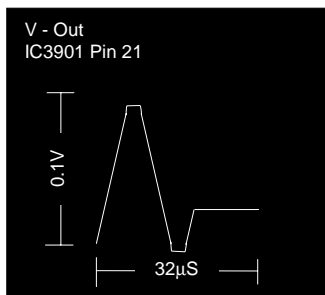
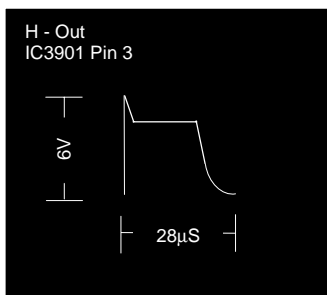
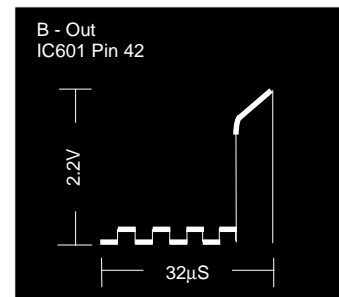
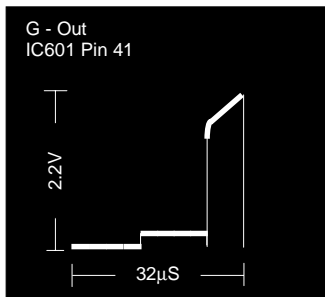
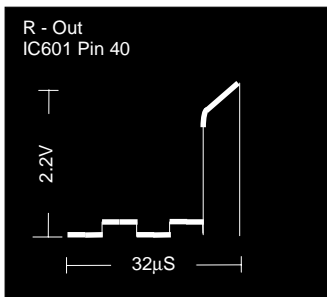
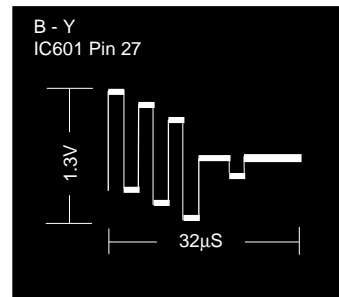
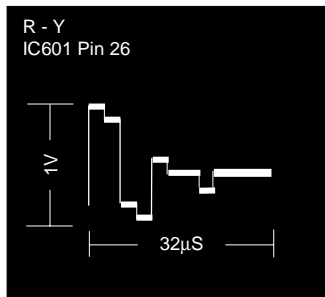
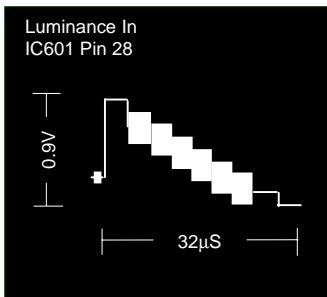
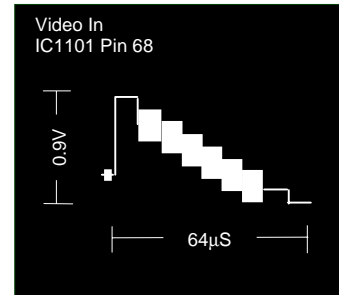
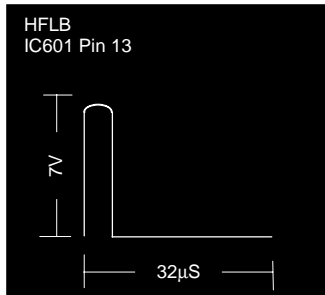
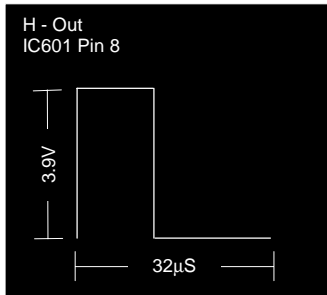
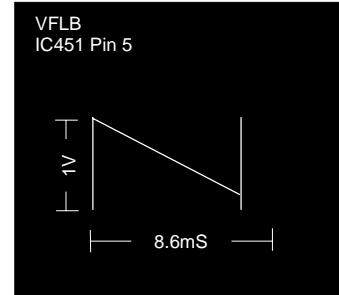
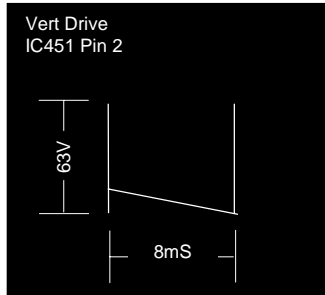
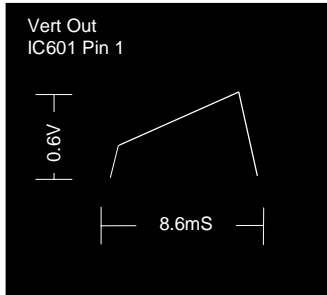

## ALIGNMENT SETTINGS:

(The figures below are nominal and used for representative purposes only.)

1. Set the Bass to maximum position, set the Treble to minimum position, press the down button (- / v) on the customer controls at the front of the TV and at the same time press the **INDEX** button on the remote control, this will place the TV into the Service Mode.
2. Press the **RED / GREEN** buttons to step up / down through the functions.
3. Press the **YELLOW / BLUE** buttons to alter the function values.
4. Press the **STR** button after each adjustment has been made to store the required values.
5. To exit the Service Mode, press the **"N"** button.

Alignment Function		Settings / Special features
Horizontal Position	H-Pos +020	Optimum setting.
Vertical Position	V-Pos +024	Optimum setting.
Horizontal Amplitude	H-Amp +049	Optimum setting.
Vert. Amplitude	V-Amp +029	Optimum setting.
EW-amplitude	E/W-Amp1 +022	Optimum setting.
EW-amplitude	E/W-Amp2 +000	Optimum setting.
Trapezium-comp	Trapez-1 +033	Optimum setting.
Horizontal-Parallel	H-Parallel +032	Optimum setting.
Vertical Linearity	V-Lin +004	Optimum setting.
DVCO	DVCO 000	Receive a PAL Colour Bar Pattern. For DVCO alignment press <b>"Blue"</b> button, wait until the colours are stable and press <b>"STR"</b> .
Cut-off DC	Cut-off O.K.	To adjust Cutoff adjust the screen VR until the display shows "O.K."
Highlight	High 0031 0031 0031	Contrast Maximum A.I. Off Optimum setting.
Sub-Brightness	Sub-Brightness 000	Optimum setting.

## ABGLEICHTABELLE:

(Die angegebenen Werte sind Mittelwerte und Können individuell nach oben oder unten nach dem korrekten Abgleich abweichen.)

1. Um in den Service-Mode zu gelangen, gehen sie bitte wie folgt vor.
2. Stellen sie im Toneinstellungs-Menü die Bässe auf Maximum und die Höhen auf Minimum.
3. Halten sie die **INDEX**-Taste auf der Fernbedienung gedrückt und drücken zusätzlich die Taste **-V** im Bedienteil des TV-Gerätes. Auf dem Bildschirm erscheint die entsprechende Anzeige für den Service-Mode.
4. Die einzelnen Funktionen mit Hilfe der **ROTEN** und **GRÜNEN** Taste anwählen.
5. Mit der **GELBEN** und **BLAUEN** Taste die Werte der einzelnen Funktionen ändern.
6. Nach jeder Einstellung die Taste **STR** auf der Fernbedienung drücken, um die geänderten Werte abzuspeichern.
7. Zum Verlassen des Service-Modus die **"N"** - Taste auf der Fernbedienung drücken.

Abgleichfunktion		Einstellung / Besondere Merkmale
Horizontal Position	H-Pos +020	Optimale Einstellung.
Vertikale Position	V-Pos +024	Optimale Einstellung.
Horizontale Amplitude	H-Amp +049	Optimale Einstellung.
Vertikale Amplitude	V-Amp +029	Optimale Einstellung.
OW-amplitude	E/W-Amp1 +022	Optimale Einstellung.
OW-amplitude	E/W-Amp2 +000	Optimale Einstellung.
Trapez-Kompensation	Trapez-1 +033	Optimale Einstellung.
Horizontale-Parallel	H-Parallel +032	Optimale Einstellung.
Vertikale linearität	V-Lin +004	Optimale Einstellung.
DVCO	DVCO 000	Ein Farbbalken-Testbild empfangen. Zum Abgleich des Farboszillators (DVCO) die <b>blau</b> Taste drücken. Nachdem ein leichtes Flackern in den Farbbalken zum Stillstand gekommen ist, die <b>STR</b> -Taste drücken.
Cut-off DC	Cut-off O.K.	Den Abgleichwert solange ändern, bis OK auf dem Bildschirm erscheint. Den Wert abspeichern.
Highlight	High 0031 0031 0031	Contrast Maximum A.I. Off Optimale Einstellung.
Sub-Brightness	Sub-Brightness 000	Optimale Einstellung.



# VIDEO BLOCK DIAGRAM

# BILD SIGNAL BLOCKSCHEMA

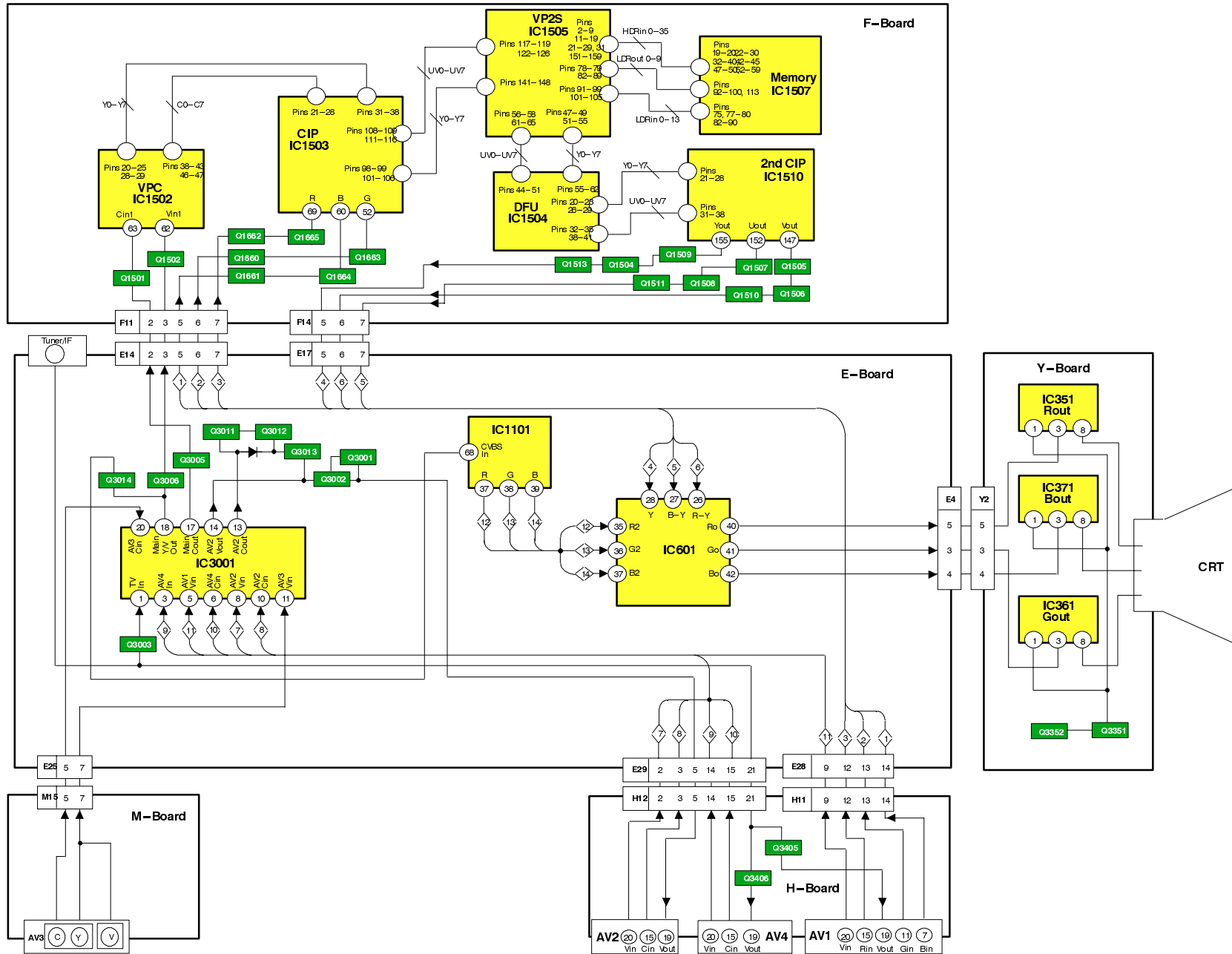

11

# AUDIO BLOCK DIAGRAM

# TONSIGNAL BLOCKSCHEMA

12

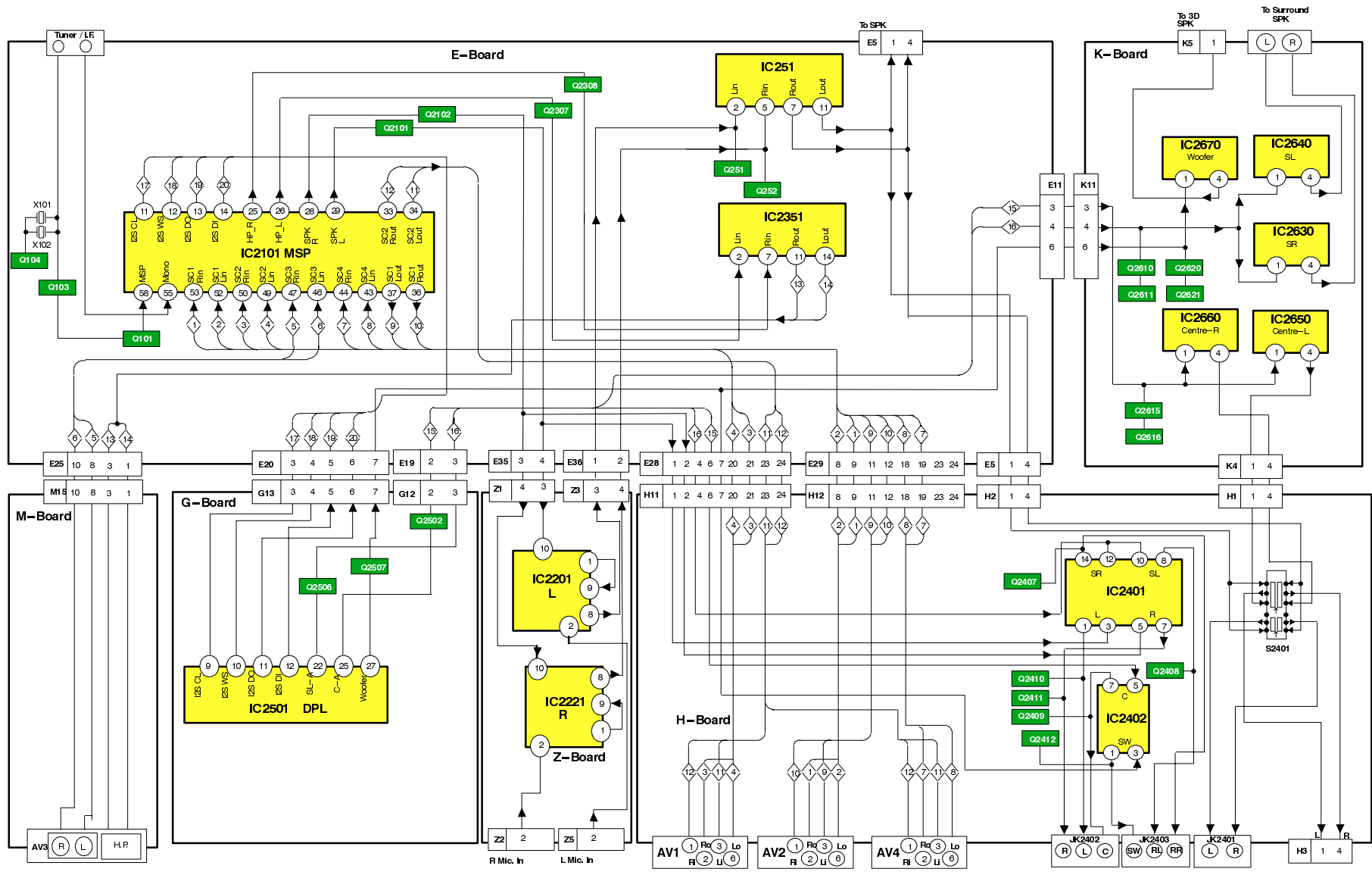

### CONTROL BLOCK DIAGRAM

### KONTROLL BLOCKSCHEMA

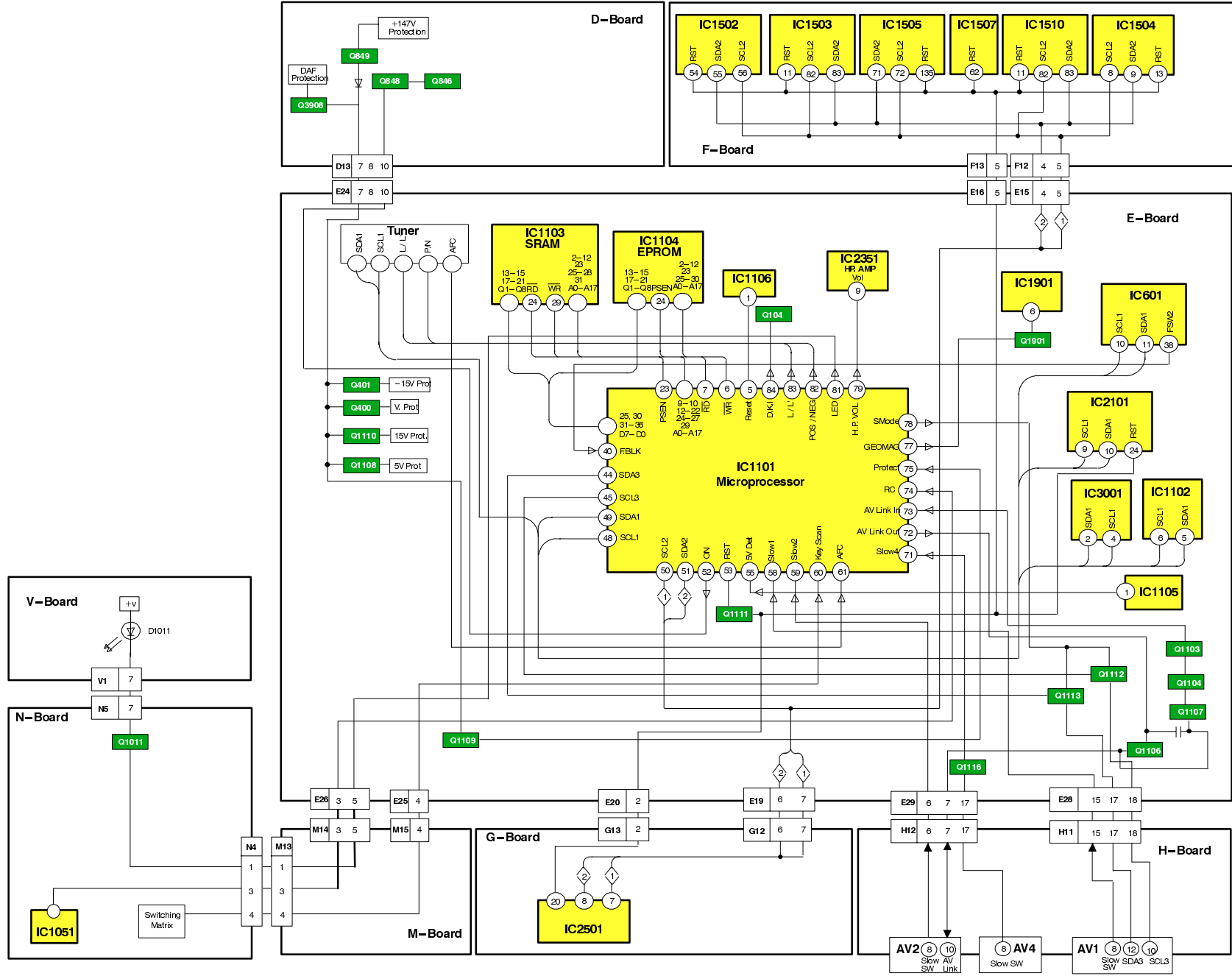



## PARTS LOCATION

**NOTE:**

The numbers on the exploded view below refer to the mechanical section of the Replacement Parts List.

## EXPLOSIONSZEICHNUNG

**Anmerkung:**

Die Nummer auf den mechanischen Teilen zeigt die Bezugsnummer der Ersatzteilliste an.

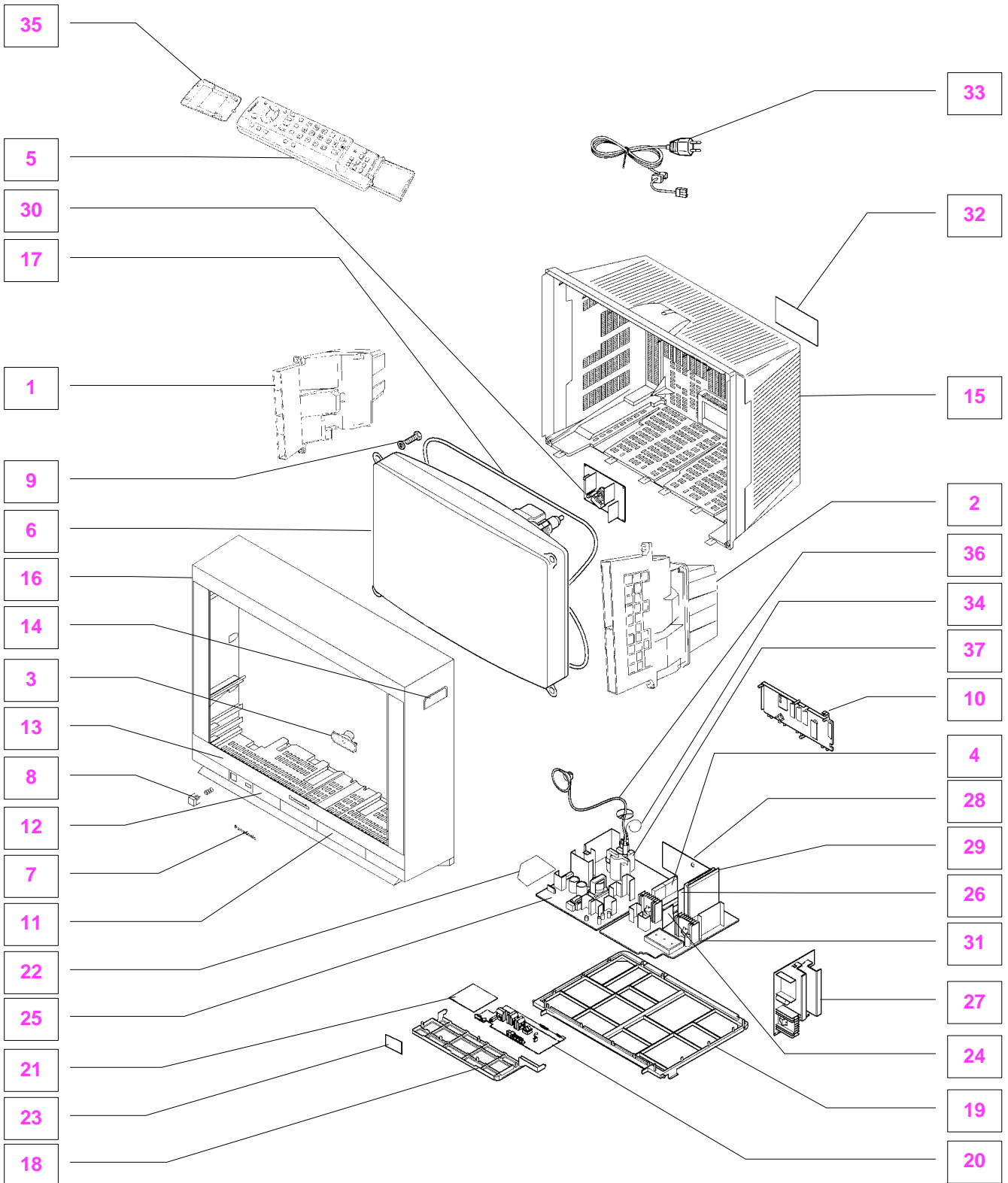

# REPLACEMENT PARTS LIST

## Important Safety Notice

Components Identified by  mark have special characteristics important for safety.

When replacing any of these components, use only manufacturers specified parts.





















\* In case of ordering these spare parts, please always add the complete Model-Type number to your order.









# ERSATZTEILLISTE

## Wichtiger Sicherheitshinweis

Teile, die mit einem Hinweis  gekennzeichnet sind wichtig für die Sicherheit. Solite ein Auswechseln erforderlich sein, sind unbedingt Originalteile einzusetzen.

Bei der Bestellung von Ersatzteilen, die mit \* gekennzeichnet sind, geben Sie bitte unbedingt die vollständige Typenbezeichnung mit an.

Cct Ref	Parts Number	Description
<b>MECHANICAL PARTS</b>		
1	EAB10106BL	LEFT SPEAKER
2	EAB10106BR	RIGHT SPEAKER
3	EASG12D123L2	CENTRE SPEAKER
4	ENG29505GR	TUNER 
5	EUR511211	REMOTE CONTROL
6	M79LQM185X05	C.R.T.
7	TBMA059	PANASONIC BADGE
8	TBXA20001	POWER BUTTON
9	THT1062	CRT FIXING SCREW
10	TKP8E1243	REAR AV COVER
11	TKPA28402	DOOR LID RIGHT
12	TKPA28502	DOOR LID LEFT
13	TKPA28603	FRONT PANEL
14	TKRA14102	CABINET HANDLE
15	TKUC06603	BACK COVER 
16	TKYA11908	CABINET 
17	TLK8E05151	DEGAUSS COIL 
18	TMW8E040	CONTROL BRACKET
19	TMX8E034	CHASSIS FRAME
20	TNP8EM019AB	M P.C.B. 
21	TNP8EN018AD	N P.C.B. 
22	TNP8EQ002AA	Q P.C.B. 
23	TNP8EV004AA	V P.C.B. 
24	TNP8EZ001AF	Z P.C.B. 
25	TNPA0876AJ	D P.C.B. 
26	TNPA0877AD	G P.C.B. 
27	TNPA1046AD	K P.C.B. 
28	TNPA1047AF	H P.C.B. 
29	TNPA1068AC	F P.C.B. 
30	TNPA1353AM	Y P.C.B. 
31	TNPH0176BH	E P.C.B. 
32	TQF8E2820	MODEL LABEL 
33	TSX8E0033	POWER CORD 
34	TXFYA010BXQG	FOCUS LEAD ASSY 
35	UR51EC904A	BATTERY COVER (REMOTE)
36	ZTBZAD650A	ANODE LEAD 
37	ZTFL77002A	F.B.T. 
<b>MISCELLANEOUS COMPONENTS</b>		
	31221212478	FIX CLIP
	832AG11D-ESL	IC SOCKET
	PLCC-84-T	84 PIN IC SOCKET
	TBLG019	SET FOOT (FRONT)
	TBLG3020	SET FOOT (REAR)
	TBM8E1915	AV PANEL LABEL
	TBM8E1930	PRESET LABEL RIGHT
	TBM8E1931	PRESET LABEL LEFT
	TEK6940	LID CATCH
	TES2298	CRT EARTH SPRING
	TES8E019	POWER BUTTON SPRING
	TESA031	FIXING SPRING
	TKPA28701	ORNAMENTAL PANEL

Cct Ref	Parts Number	Description
	TLK8E05124	GEOMAGNETIC COIL 
	TLK8E05150	CANCELLATION COIL 
	TMX8E025	P.C.B. BRACKET
	TMX8E035	POWER BUTTON JOINT
	TPC8E4777-1	OUTER CARTON
	TPD8E701	TOP CUSHION
	TPD8E702	BOTTOM CUSHION
	UM-3DJ-2P	BATTERY PACK
R842	232266296706	THERMISTOR 
R843	232266296706	THERMISTOR 
RL801	TSE1885-1	RELAY
<b>INSTRUCTION BOOKS</b>		
	TQB8E2732A-1	GERMAN 
	TQB8E2732BD1	DUTCH/FRENCH 
	TQB8E2732CE1	ITALIAN/SPANISH 
	TQB8E2732FG1	SWEDISH/NORG. 
	TQB8E2732HK1	SUOMI/DANISH 
<b>I.C.s</b>		
IC251	LA4282	AUDIO OUTPUT
IC351	TDA6111Q-N4	RGB OUTPUT
IC361	TDA6111Q-N4	RGB OUTPUT
IC371	TDA6111Q-N4	RGB OUTPUT
IC381	TL431ACLPM	REGULATOR
IC451	LA7845N	VERTICAL OUTPUT
IC601	TDA9330HN1G	VIDEO PROCESSOR
IC801	AN8029	POWER SUPPLY
IC845	SE140N	ERROR AMPLIFIER
IC852	TL431ACLPM	REGULATOR
IC1051	RPM6937-S	LED RECEIVER
IC1101	SDA5450C48-1	MICRO PROCESSOR
IC1102	X24C0501WD	EAROM *
IC1103	KM681000CLP	SRAM
IC1104	27C2001-H12	EPROM *
IC1105	MN1381-T(TA)	RESET
IC1106	MN1381-R(TA)	RESET
IC1502	VPC3215CB4TP	VPC
IC1503	MB87F1720	CIP
IC1504	FJB007S	DFU
IC1505	MB87F2131	VP2S
IC1506	AN77L035M-E1	3.5V REGULATOR
IC1507	MB87H2010	MEMORY
IC1509	TLC2932IPWL	CLOCK CONVERTOR
IC1510	MB87F1720	CIP
IC1901	LA6515	EARTH CORRECTION
IC2101	MSP3410DPPB4	AUDIO PROCESSOR
IC2201	AN6554NSF-E2	OPERATIONAL AMPLIFIER
IC2221	AN6554NSF-E2	OPERATIONAL AMPLIFIER
IC2351	AN7108	H.P. AMPLIFIER
IC2401	AN6554NSF-E2	OPERATIONAL AMPLIFIER
IC2402	BA15218F-E2	AMPLIFIER
IC2501	DPL3519APOA2	DOLBY PROCESSOR
IC2551	STR10006-S	POWER SUPPLY

Cct Ref	Parts Number	Description
IC2630	TDA2030AV	AUDIO AMPLIFIER
IC2640	TDA2030AV	AUDIO AMPLIFIER
IC2650	TDA2030AV	AUDIO AMPLIFIER
IC2660	TDA2030AV	AUDIO AMPLIFIER
IC2670	TDA2030AV	AUDIO AMPLIFIER
IC3001	TEA6415C	VIDEO SWITCH
IC3801	AN7809FLB	9V REGULATOR
IC3802	AN7708FLB	8V REGULATOR
IC3805	AN7808LB	8V REGULATOR
IC3806	SI-3033C	3.5V REGULATOR
IC3901	AN5422K	DYNAMIC FOCUS
<b>FUSES</b>		
F840	XBA2C50TH15	FUSE
F845	TR5-T3150	FUSE
F846	TR5-T1250	FUSE
F8401	EYF52BC	FUSE HOLDER
F8402	EYF52BC	FUSE HOLDER
<b>DIODES</b>		
D001	MA4020	DIODE
D002	MA4020	DIODE
D252	MA165TA5	DIODE
D253	MA700TA5	DIODE
D254	MA700TA5	DIODE
D255	MA165TA5	DIODE
D256	MA165TA5	DIODE
D287	MA4200	DIODE
D351	ERA15-04V3	DIODE
D352	ERA15-04V3	DIODE
D361	ERA15-04V3	DIODE
D362	ERA15-04V3	DIODE
D371	ERA15-04V3	DIODE
D372	ERA15-04V3	DIODE
D373	MTZJT-7715A	DIODE
D374	MTZJT-7715A	DIODE
D375	MTZJT-7715A	DIODE
D387	MA2160LFS	DIODE
D400	MA4104	DIODE
D401	MA165TA5	DIODE
D402	MA165TA5	DIODE
D404	EU02AV1	DIODE
D405	MA165TA5	DIODE
D408	MA165TA5	DIODE
D502	1SS254T-77	DIODE
D503	EU02	DIODE
D504	EU02	DIODE
D505	ERA81004V3	DIODE
D556	AU02V0	DIODE
D559	MTZJT-7736A	DIODE
D560	1SS252T-77	DIODE
D563	RH3GLF102	DIODE
D571	FMV-3GULF730	DIODE
D575	1SS252T-77	DIODE
D601	MA29TA5	DIODE
D603	MA4075	DIODE
D605	MA4062	DIODE
D607	MA165TA5	DIODE
D610	MA4043	DIODE
D611	MA165TA5	DIODE
D612	MA165TA5	DIODE
D615	MA165TA5	DIODE
D616	MA178TA5	DIODE
D617	MTZJT-779.1C	DIODE
D618	MTZJT-779.1C	DIODE
D621	MTZJT-778.2A	DIODE
D651	MA165TA5	DIODE
D652	MA165TA5	DIODE

△  
△  
△

Cct Ref	Parts Number	Description
D653	MA4360	DIODE
D654	MTZJT-777.5B	DIODE
D701	AU02V0	DIODE
D703	MA29TA5	DIODE
D803	MTZJT-7712C	DIODE
D806	TF361MALF3	DIODE
D807	RBV-608LF-B	DIODE
D808	MA165TA5	DIODE
D809	ERA22-02V3	DIODE
D810	MA2180BLFS	DIODE
D812	MTZJT-775.6B	DIODE
D813	MA700TA5	DIODE
D814	AU01ZV0	DIODE
D815	PC123FY2	DIODE
D817	D5L60F4015	DIODE
D818	TMPG10G3	DIODE
D819	ERA81004V3	DIODE
D820	MA4100	DIODE
D821	EU02AV0	DIODE
D845	MA165TA5	DIODE
D846	EK04V0	DIODE
D847	ERA15-01V3	DIODE
D848	EU02	DIODE
D849	FMGG26S	DIODE
D850	ERB32-02E	DIODE
D851	FMGG2CSLF116	DIODE
D852	MA4062	DIODE
D853	1N4150T-77	DIODE
D854	ERA15-01V3	DIODE
D855	D10SC6MRL	DIODE
D856	MA165TA5	DIODE
D857	FML22SLF610	DIODE
D860	1SS254T-77	DIODE
D861	MTZJT-775.1C	DIODE
D866	MTZJT-7727D	DIODE
D901	1SS254T-77	DIODE
D902	1SS254T-77	DIODE
D903	1SS254T-77	DIODE
D910	R2KNLFA1	DIODE
D1011	LN81RPHL	DIODE
D1102	MA4051	DIODE
D1103	MA4051	DIODE
D1104	MA165TA5	DIODE
D1105	MA165TA5	DIODE
D1107	MA165TA5	DIODE
D1109	MA165TA5	DIODE
D1110	MA165TA5	DIODE
D1112	MA165TA5	DIODE
D1501	MA151ATX	DIODE
D2101	MTZJT-7712C	DIODE
D2102	MTZJT-7712C	DIODE
D2351	MTZJT-775.6B	DIODE
D2401	MA165TA5	DIODE
D2403	MTZJT-7712C	DIODE
D2404	MTZJT-7712C	DIODE
D2405	MTZJT-7712C	DIODE
D2406	MTZJT-7712C	DIODE
D2407	MTZJT-7712C	DIODE
D2408	MTZJT-7712C	DIODE
D2551	D5L60F4015	DIODE
D2552	TVSEH1LF-F7	DIODE
D2553	MTZJT-778.2A	DIODE
D2554	EU02	DIODE
D2555	EU02	DIODE
D2556	EG01CV0	DIODE
D2558	EU02	DIODE



Cct Ref	Parts Number	Description
D2559	RU4AMLF-M1	DIODE
D2560	MTZJT-7727D	DIODE
D2611	MA165TA5	DIODE
D2616	MA165TA5	DIODE
D2619	MA165TA5	DIODE
D2621	MA165TA5	DIODE
D2622	MA165TA5	DIODE
D2623	MA165TA5	DIODE
D2624	MA4200	DIODE
D2630	MA165TA5	DIODE
D2631	MA165TA5	DIODE
D2640	MA165TA5	DIODE
D2641	MA165TA5	DIODE
D2650	MA165TA5	DIODE
D2651	MA165TA5	DIODE
D2660	MA165TA5	DIODE
D2661	MA165TA5	DIODE
D2670	MA165TA5	DIODE
D2671	MA165TA5	DIODE
D2672	MA165TA5	DIODE
D3006	MA4100	DIODE
D3008	MA723TA5	DIODE
D3009	MA170	DIODE
D3011	MA858TA5	DIODE
D3351	1SS254T-77	DIODE
D3352	MA165TA5	DIODE
D3353	MA165TA5	DIODE
D3354	MA165TA5	DIODE
D3401	MTZJT-7712C	DIODE
D3402	MTZJT-7712C	DIODE
D3803	MTZJT-774.7A	DIODE
D3804	MTZJT-778.2A	DIODE
D3805	ERA81004V3	DIODE
D3901	MTZJT-779.1C	DIODE
D3907	ERA22-06V3	DIODE
D3908	ERA22-06V3	DIODE
D3909	MA165TA5	DIODE
D3910	RP1HLFA5	DIODE
D3911	RP1HLFA5	DIODE
D3912	1SS254T-77	DIODE
D3915	MTZJT-7710D	DIODE
D3917	MA165TA5	DIODE
D3990	MTZJT-7724D	DIODE
<b>TRANSISTORS</b>		
Q101	BC847B	TRANSISTOR
Q103	BC847B	TRANSISTOR
Q104	BC847B	TRANSISTOR
Q251	2SD1328STX	TRANSISTOR
Q252	2SD1328STX	TRANSISTOR
Q253	BC847B	TRANSISTOR
Q254	BC857B	TRANSISTOR
Q400	BC847B	TRANSISTOR
Q401	BC847B	TRANSISTOR
Q502	2SC2925STA	TRANSISTOR
Q552	2SC5144LB230	TRANSISTOR
Q553	2SC1473-RN	TRANSISTOR
Q554	2SC1473-RN	TRANSISTOR
Q602	BC857B	TRANSISTOR
Q603	BC857B	TRANSISTOR
Q604	BC857B	TRANSISTOR
Q607	BC857B	TRANSISTOR
Q608	BC857B	TRANSISTOR
Q701	2SK2538000LB	TRANSISTOR
Q801	2SK1365LB106	TRANSISTOR
Q803	2SD965-R	TRANSISTOR
Q804	2SA719-TA	TRANSISTOR

Cct Ref	Parts Number	Description
Q845	2SA684R	TRANSISTOR
Q846	BC847B	TRANSISTOR
Q847	BC857B	TRANSISTOR
Q848	BC847B	TRANSISTOR
Q849	2SA1018QTA	TRANSISTOR
Q850	2SD1474PLB	TRANSISTOR
Q852	2SC1318-S	TRANSISTOR
Q853	BC857C	TRANSISTOR
Q854	BC857C	TRANSISTOR
Q902	BC847B	TRANSISTOR
Q903	BC847B	TRANSISTOR
Q904	BC857B	TRANSISTOR
Q905	BC847B	TRANSISTOR
Q906	BC847B	TRANSISTOR
Q907	BC857B	TRANSISTOR
Q908	2SA1535ARLB	TRANSISTOR
Q909	2SC3944ARLB	TRANSISTOR
Q1011	BC557B/126	TRANSISTOR
Q1103	BC847B	TRANSISTOR
Q1104	BC847B	TRANSISTOR
Q1105	BC847B	TRANSISTOR
Q1106	BC847B	TRANSISTOR
Q1107	BC847B	TRANSISTOR
Q1108	BC847B	TRANSISTOR
Q1109	BC847B	TRANSISTOR
Q1110	BC847B	TRANSISTOR
Q1111	BC847B	TRANSISTOR
Q1112	BC847B	TRANSISTOR
Q1113	BC847B	TRANSISTOR
Q1116	BC847B	TRANSISTOR
Q1118	BC857B	TRANSISTOR
Q1501	BC857B	TRANSISTOR
Q1502	BC857B	TRANSISTOR
Q1503	BC847B	TRANSISTOR
Q1504	BC847B	TRANSISTOR
Q1505	BC847B	TRANSISTOR
Q1506	BC847B	TRANSISTOR
Q1507	BC847B	TRANSISTOR
Q1508	BC847B	TRANSISTOR
Q1509	BC847B	TRANSISTOR
Q1510	BC847B	TRANSISTOR
Q1511	BC847B	TRANSISTOR
Q1513	BC857B	TRANSISTOR
Q1660	BC847B	TRANSISTOR
Q1661	BC847B	TRANSISTOR
Q1662	BC847B	TRANSISTOR
Q1663	BC847B	TRANSISTOR
Q1664	BC847B	TRANSISTOR
Q1665	BC847B	TRANSISTOR
Q1666	BC847B	TRANSISTOR
Q1667	BC847B	TRANSISTOR
Q1901	BC847B	TRANSISTOR
Q2101	BC860B	TRANSISTOR
Q2102	BC860B	TRANSISTOR
Q2103	BC860B	TRANSISTOR
Q2201	BC847B	TRANSISTOR
Q2202	BC847B	TRANSISTOR
Q2301	BC847B	TRANSISTOR
Q2302	BC847B	TRANSISTOR
Q2305	BC857B	TRANSISTOR
Q2307	BC860B	TRANSISTOR
Q2308	BC860B	TRANSISTOR
Q2351	BC847B	TRANSISTOR
Q2352	BC847B	TRANSISTOR
Q2401	BC847B	TRANSISTOR
Q2407	BC847B	TRANSISTOR

Cct Ref	Parts Number	Description
Q2408	BC847B	TRANSISTOR
Q2409	BC847B	TRANSISTOR
Q2410	BC847B	TRANSISTOR
Q2411	BC847B	TRANSISTOR
Q2412	2SD1328STX	TRANSISTOR
Q2502	BC857B	TRANSISTOR
Q2506	BC857B	TRANSISTOR
Q2507	BC857B	TRANSISTOR
Q2554	2SA684R	TRANSISTOR
Q2555	BC557B/126	TRANSISTOR
Q2610	2SD1328STX	TRANSISTOR
Q2611	BC857B	TRANSISTOR
Q2615	2SD1328STX	TRANSISTOR
Q2616	BC857B	TRANSISTOR
Q2620	2SD1328STX	TRANSISTOR
Q2621	BC857B	TRANSISTOR
Q3001	BC857B	TRANSISTOR
Q3002	BC847B	TRANSISTOR
Q3003	BC847B	TRANSISTOR
Q3005	BC847B	TRANSISTOR
Q3006	BC847B	TRANSISTOR
Q3007	BC847B	TRANSISTOR
Q3008	BC847B	TRANSISTOR
Q3010	BC857B	TRANSISTOR
Q3011	BC857B	TRANSISTOR
Q3012	BC847B	TRANSISTOR
Q3013	BC847B	TRANSISTOR
Q3014	BC847B	TRANSISTOR
Q3351	BC847B	TRANSISTOR
Q3352	BC857B	TRANSISTOR
Q3401	BC847B	TRANSISTOR
Q3402	BC847B	TRANSISTOR
Q3403	BC847B	TRANSISTOR
Q3404	BC847B	TRANSISTOR
Q3405	BC847B	TRANSISTOR
Q3406	BC847B	TRANSISTOR
Q3801	2SD1474PLB	TRANSISTOR
Q3901	BC847B	TRANSISTOR
Q3902	BC847B	TRANSISTOR
Q3903	BC847B	TRANSISTOR
Q3904	BC857B	TRANSISTOR
Q3905	2SK1006RF122	TRANSISTOR
Q3906	2SC4572RB	TRANSISTOR
Q3907	BC847B	TRANSISTOR
Q3908	BC847B	TRANSISTOR
Q3911	BC847B	TRANSISTOR
Q3912	BC847B	TRANSISTOR
Q3990	BC847B	TRANSISTOR
<b>TRANSFORMERS</b>		
T501	ETH19Y187AY	TRANSFORMER
T801	ETP35KAN619U	TRANSFORMER
T802	ETS49AH1W7AD	TRANSFORMER
T2552	ETS35AA457AD	TRANSFORMER
T3901	ETF18L37B	TRANSFORMER
<b>COILS</b>		
J5	ELESN2R2KA	COIL
J341	EXCELSA39V	COIL
J361	EXCELSA39V	COIL
JA1	ELJFC2R2KF	COIL
JA10	ELJFC2R2KF	COIL
L002	EXCELD35V	COIL
L003	EXCELD35V	COIL
L004	EXCELSA35T	COIL
L005	TLT100K991R	COIL
L007	EXCELD35V	COIL
L008	ELJFC2R2KF	COIL



Cct Ref	Parts Number	Description
L009	ELJFC2R2KF	COIL
L251	EXCELSA35T	COIL
L252	EXCELSA35T	COIL
L253	EXCELSA35T	COIL
L254	EXCELSA35T	COIL
L351	ELB4C070B	DELAY LINE
L361	ELB4C070B	DELAY LINE
L371	ELB4C070B	DELAY LINE
L381	TLT220K991R	COIL
L383	EXCELSA35T	COIL
L501	ELELN101KA	COIL
L554	EXCELSA35T	COIL
L555	EXCELD35V	COIL
L556	EXCELD35C	COIL
L557	EXCELD35C	COIL
L572	ELHKL061B	COIL
L573	ELHKL062B	COIL
L575	ELC18B331F	COIL
L601	EXCELD35V	COIL
L602	EXCELD35V	COIL
L603	TLT033K991R	COIL
L604	ELEXT2R7KA	COIL
L605	ELEXT2R7KA	COIL
L606	ELEXT2R7KA	COIL
L607	ELEXT2R7KA	COIL
L701	ELC18B801L	COIL
L806	EXCELSA39V	COIL
L808	EXCELSA39V	COIL
L809	EXCELD35C	COIL
L810	EXCELSA39V	COIL
L811	EXCELSA39V	COIL
L812	EXCELD35V	COIL
L813	EXCELD35V	COIL
L817	EXCELD35V	COIL
L819	EXCELSA39V	COIL
L845	EXCELSA35T	COIL
L847	EXCELSA35B	COIL
L849	EXCELSA35T	COIL
L854	ELEIE150KA	COIL
L859	EXCELSA35T	COIL
L860	EXCELSA35T	COIL
L861	EXCELSA35T	COIL
L910	EXCELSA35T	COIL
L911	EXCELSA35T	COIL
L912	EXCELSA35T	COIL
L1101	EXCELD35V	COIL
L1103	TLT047K991R	COIL
L1104	EXCELD35V	COIL
L1105	EXCELD35V	COIL
L1106	TLT047K991R	COIL
L1507	TLT018K991R	COIL
L1508	TLT033K991R	COIL
L1509	EXCELD35V	COIL
L1510	EXCELD35V	COIL
L1511	TLT018K991R	COIL
L1516	EXCELD35V	COIL
L1519	EXCEMT103DTM	COIL
L1523	EXCEMT103DTM	COIL
L1525	EXCEMT103DTM	COIL
L1527	EXCEMT103DTM	COIL
L1528	EXCELD35V	COIL
L1529	EXCELD35V	COIL
L1532	EXCELD35V	COIL
L1533	EXCELD35V	COIL
L1534	EXCELD35V	COIL
L1535	EXCELD35V	COIL

Cct Ref	Parts Number	Description
L1536	EXCELD35V	COIL
L1537	TLT100K991R	COIL
L1538	TLT018K991R	COIL
L1539	TLT033K991R	COIL
L1540	TLT018K991R	COIL
L1541	TLT033K991R	COIL
L1542	TLT018K991R	COIL
L1543	TLT033K991R	COIL
L1901	EXCELD35V	COIL
L2101	TLT100K991R	COIL
L2102	TLT039K991R	COIL
L2103	TLT100K991R	COIL
L2104	EXCELD35V	COIL
L2106	TLT068K991R	COIL
L2201	EXCELD35V	COIL
L2381	EXCELSA35T	COIL
L2382	EXCELSA35T	COIL
L2401	EXCELSA35T	COIL
L2402	EXCELSA35T	COIL
L2403	EXCELSA35T	COIL
L2404	EXCELSA35T	COIL
L2409	EXCELSA35T	COIL
L2410	EXCELSA35T	COIL
L2411	EXCELSA35T	COIL
L2412	EXCELSA35T	COIL
L2413	EXCELSA35T	COIL
L2414	EXCELSA35T	COIL
L2502	EXCELD35V	COIL
L2503	EXCELD35V	COIL
L2504	EXCELD35V	COIL
L2505	EXCEMT103DTM	COIL
L2506	EXCEMT103DTM	COIL
L2551	EXCELSA35T	COIL
L2552	EXCELSA35T	COIL
L2553	EXCELSA35T	COIL
L2555	EXCELSA35T	COIL
L2556	EXCELSA35T	COIL
L2560	EXCELSA35T	COIL
L2561	EXCELSA35T	COIL
L2670	5770206400	COIL
L2671	5770206400	COIL
L3001	TLT100K991R	COIL
L3205	EXCELD35V	COIL
L3281	EXCELSA35T	COIL
L3282	EXCELSA35T	COIL
L3401	TLT015K991R	COIL
L3402	TLT015K991R	COIL
L3403	TLT015K991R	COIL
L3404	TLT015K991R	COIL
L3405	TLT015K991R	COIL
L3406	TLT015K991R	COIL
L3407	TLT015K991R	COIL
L3408	TLT015K991R	COIL
L3409	TLT100K991R	COIL
L3410	TLT015K991R	COIL
L3411	TLT015K991R	COIL
L3412	TLT015K991R	COIL
L3413	TLT015K991R	COIL
L3801	EXCELD35V	COIL
L3901	EXCELSA35T	COIL
L3902	ELC08D102E	COIL
<b>FILTERS</b>		
L840	ELF18N016A	LINE FILTER
L841	ELF18N016A	LINE FILTER
T803	ETQ24K37AY	LINE FILTER
X101	EFCT6504BF	FILTER

Cct Ref	Parts Number	Description			
X102	EFCT7004BF	CERAMIC FILTER			
<b>CRYSTALS</b>					
X601	TSSA010	CRYSTAL			
X1101	TSSA121	CRYSTAL			
X1501	TSS2169-B	CRYSTAL			
X2101	4730007158	CRYSTAL			
X2501	4730007158	CRYSTAL			
<b>RESISTORS</b>					
D2201	ERQ14AJW220	METAL	0.25W	5%	22 Ω <sup>△</sup>
JA1	ERJ6GEY0R00	S.M.CARB	0.1W	5%	0 Ω
JA1	ERJ8GEY0R00	S.M.CARB	.125W	5%	0 Ω
JA2	ERJ6GEY0R00	S.M.CARB	0.1W	5%	0 Ω
JA2	ERJ8GEY0R00	S.M.CARB	.125W	5%	0 Ω
JA3	ERJ6GEY0R00	S.M.CARB	0.1W	5%	0 Ω
JA3	ERJ8GEY0R00	S.M.CARB	.125W	5%	0 Ω
JA4	ERJ6GEY0R00	S.M.CARB	0.1W	5%	0 Ω
JA4	ERJ8GEY0R00	S.M.CARB	.125W	5%	0 Ω
JA5	ERJ6GEY0R00	S.M.CARB	0.1W	5%	0 Ω
JA5	ERJ8GEY0R00	S.M.CARB	.125W	5%	0 Ω
JA6	ERJ6GEY0R00	S.M.CARB	0.1W	5%	0 Ω
JA6	ERJ8GEY0R00	S.M.CARB	.125W	5%	0 Ω
JA7	ERJ6GEY0R00	S.M.CARB	0.1W	5%	0 Ω
JA7	ERJ8GEY0R00	S.M.CARB	.125W	5%	0 Ω
JA8	ERJ6GEY0R00	S.M.CARB	0.1W	5%	0 Ω
JA8	ERJ8GEY0R00	S.M.CARB	.125W	5%	0 Ω
JA9	ERJ6GEY0R00	S.M.CARB	0.1W	5%	0 Ω
JA10	ERJ6GEY0R00	S.M.CARB	0.1W	5%	0 Ω
JA11	ERJ6GEY0R00	S.M.CARB	0.1W	5%	0 Ω
JA12	ERJ6GEY0R00	S.M.CARB	0.1W	5%	0 Ω
JA13	ERJ6GEY0R00	S.M.CARB	0.1W	5%	0 Ω
JA13	ERJ8GEY0R00	S.M.CARB	.125W	5%	0 Ω
JA14	ERJ6GEY0R00	S.M.CARB	0.1W	5%	0 Ω
JA14	ERJ8GEY0R00	S.M.CARB	.125W	5%	0 Ω
JA15	ERJ8GEY0R00	S.M.CARB	.125W	5%	0 Ω
JA16	ERJ8GEY0R00	S.M.CARB	.125W	5%	0 Ω
JA18	ERJ6GEY0R00	S.M.CARB	0.1W	5%	0 Ω
JA19	ERJ6GEY0R00	S.M.CARB	0.1W	5%	0 Ω
JA20	ERJ8GEY0R00	S.M.CARB	.125W	5%	0 Ω
JA21	ERJ6GEY0R00	S.M.CARB	0.1W	5%	0 Ω
JA23	ERJ6GEY0R00	S.M.CARB	0.1W	5%	0 Ω
JA24	ERJ6GEY0R00	S.M.CARB	0.1W	5%	0 Ω
JA26	ERJ6GEY0R00	S.M.CARB	0.1W	5%	0 Ω
JA27	ERJ6GEY0R00	S.M.CARB	0.1W	5%	0 Ω
JA29	ERJ6GEY0R00	S.M.CARB	0.1W	5%	0 Ω
JA30	ERJ6GEY0R00	S.M.CARB	0.1W	5%	0 Ω
JA31	ERJ6GEY0R00	S.M.CARB	0.1W	5%	0 Ω
JA33	ERJ6GEY0R00	S.M.CARB	0.1W	5%	0 Ω
JA35	ERJ8GEY0R00	S.M.CARB	.125W	5%	0 Ω
JA36	ERJ6GEY0R00	S.M.CARB	0.1W	5%	0 Ω
JA37	ERJ6GEY0R00	S.M.CARB	0.1W	5%	0 Ω
JA38	ERJ8GEY0R00	S.M.CARB	.125W	5%	0 Ω
JA39	ERJ8GEY0R00	S.M.CARB	.125W	5%	0 Ω
JA40	ERJ6GEY0R00	S.M.CARB	0.1W	5%	0 Ω
JA41	ERJ6GEY0R00	S.M.CARB	0.1W	5%	0 Ω
JA42	ERJ6GEY0R00	S.M.CARB	0.1W	5%	0 Ω
JC1	ERJ6GEY0R00	S.M.CARB	0.1W	5%	0 Ω
JSE004	ERJ6GEY0R00	S.M.CARB	0.1W	5%	0 Ω
JSE009	ERJ6GEY0R00	S.M.CARB	0.1W	5%	0 Ω
JSE011	ERJ6GEY0R00	S.M.CARB	0.1W	5%	0 Ω
JSE025	ERJ6GEY0R00	S.M.CARB	0.1W	5%	0 Ω
JSE026	ERJ6GEY0R00	S.M.CARB	0.1W	5%	0 Ω
JSE032	ERJ6GEY0R00	S.M.CARB	0.1W	5%	0 Ω
JSE044	ERJ6GEY0R00	S.M.CARB	0.1W	5%	0 Ω
JSE050	ERJ8GEY0R00	S.M.CARB	.125W	5%	0 Ω
JSE055	ERJ6GEY0R00	S.M.CARB	0.1W	5%	0 Ω
JSF001	ERJ6GEY0R00	S.M.CARB	0.1W	5%	0 Ω

Cct Ref	Parts Number	Description			
JSF005	ERJ6GEY0R00	S.M.CARB	0.1W	5%	0 Ω
JSF006	ERJ6GEY0R00	S.M.CARB	0.1W	5%	0 Ω
JSF007	ERJ6GEY0R00	S.M.CARB	0.1W	5%	0 Ω
JSF009	ERJ6GEY0R00	S.M.CARB	0.1W	5%	0 Ω
JSF010	ERJ6GEY0R00	S.M.CARB	0.1W	5%	0 Ω
JSF013	ERJ6GEY0R00	S.M.CARB	0.1W	5%	0 Ω
JSF015	ERJ6GEY0R00	S.M.CARB	0.1W	5%	0 Ω
JSF017	ERJ6GEY0R00	S.M.CARB	0.1W	5%	0 Ω
JSF018	ERJ6GEY0R00	S.M.CARB	0.1W	5%	0 Ω
JSF019	ERJ6GEY0R00	S.M.CARB	0.1W	5%	0 Ω
JSF020	ERJ6GEY0R00	S.M.CARB	0.1W	5%	0 Ω
JSF021	ERJ6GEY0R00	S.M.CARB	0.1W	5%	0 Ω
JSF022	ERJ6GEY0R00	S.M.CARB	0.1W	5%	0 Ω
JSF023	ERJ6GEY0R00	S.M.CARB	0.1W	5%	0 Ω
JSF024	ERJ6GEY0R00	S.M.CARB	0.1W	5%	0 Ω
JSF025	ERJ6GEY0R00	S.M.CARB	0.1W	5%	0 Ω
JSF026	ERJ6GEY0R00	S.M.CARB	0.1W	5%	0 Ω
JSF027	ERJ6GEY0R00	S.M.CARB	0.1W	5%	0 Ω
JSF028	ERJ6GEY0R00	S.M.CARB	0.1W	5%	0 Ω
JSF029	ERJ6GEY0R00	S.M.CARB	0.1W	5%	0 Ω
JSF032	ERJ6GEY0R00	S.M.CARB	0.1W	5%	0 Ω
JSF034	ERJ6GEY0R00	S.M.CARB	0.1W	5%	0 Ω
JSF037	ERJ6GEY0R00	S.M.CARB	0.1W	5%	0 Ω
JSF039	ERJ6GEY0R00	S.M.CARB	0.1W	5%	0 Ω
JSF041	ERJ6GEY0R00	S.M.CARB	0.1W	5%	0 Ω
JSF042	ERJ6GEY0R00	S.M.CARB	0.1W	5%	0 Ω
JSF043	ERJ6GEY0R00	S.M.CARB	0.1W	5%	0 Ω
JSG9	ERJ6GEY0R00	S.M.CARB	0.1W	5%	0 Ω
JSG10	ERJ6GEY0R00	S.M.CARB	0.1W	5%	0 Ω
JSG14	ERJ6GEY0R00	S.M.CARB	0.1W	5%	0 Ω
JSH002	ERJ6GEY0R00	S.M.CARB	0.1W	5%	0 Ω
JSH009	ERJ6GEY0R00	S.M.CARB	0.1W	5%	0 Ω
JSK021	ERJ6GEY0R00	S.M.CARB	0.1W	5%	0 Ω
JSY03	ERJ6GEY0R00	S.M.CARB	0.1W	5%	0 Ω
JSY04	ERJ6GEY0R00	S.M.CARB	0.1W	5%	0 Ω
JSZ001	ERJ6GEY0R00	S.M.CARB	0.1W	5%	0 Ω
JSZ003	ERJ6GEY0R00	S.M.CARB	0.1W	5%	0 Ω
JSZ005	ERJ6GEY0R00	S.M.CARB	0.1W	5%	0 Ω
R001	ERJ6GEYJ223	S.M.CARB	0.1W	5%	22K Ω
R002	ERJ6GEYJ101	S.M.CARB	0.1W	5%	100 Ω
R003	ERJ6GEYJ393	S.M.CARB	0.1W	5%	39K Ω
R101	ERJ6GEYJ561	S.M.CARB	0.1W	5%	560 Ω
R102	ERJ6GEYJ101	S.M.CARB	0.1W	5%	100 Ω
R103	ERJ6GEYJ563	S.M.CARB	0.1W	5%	56K Ω
R104	ERJ6GEYJ471	S.M.CARB	0.1W	5%	470 Ω
R105	ERJ6GEYJ332	S.M.CARB	0.1W	5%	3K3 Ω
R106	ERJ6GEYJ821	S.M.CARB	0.1W	5%	820 Ω
R107	ERJ6GEYJ102	S.M.CARB	0.1W	5%	1K Ω
R109	ERJ6GEYJ103	S.M.CARB	0.1W	5%	10K Ω
R110	ERJ6GEYJ222	S.M.CARB	0.1W	5%	2K2 Ω
R111	ERJ6GEYJ331	S.M.CARB	0.1W	5%	330 Ω
R251	ERJ6GEYJ101	S.M.CARB	0.1W	5%	100 Ω
R252	ERJ6GEYJ472	S.M.CARB	0.1W	5%	4K7 Ω
R253	ERJ6GEYJ103	S.M.CARB	0.1W	5%	10K Ω
R254	ERJ6GEYJ101	S.M.CARB	0.1W	5%	100 Ω
R255	ERJ6GEYJ103	S.M.CARB	0.1W	5%	10K Ω
R256	ERJ6GEYJ471	S.M.CARB	0.1W	5%	470 Ω
R257	ERJ6GEY0R00	S.M.CARB	0.1W	5%	0 Ω
R258	ERJ6GEYJ472	S.M.CARB	0.1W	5%	4K7 Ω
R259	ERJ6GEY0R00	S.M.CARB	0.1W	5%	0 Ω
R260	ERJ6GEYJ103	S.M.CARB	0.1W	5%	10K Ω
R261	ERJ6GEYJ471	S.M.CARB	0.1W	5%	470 Ω
R262	ERJ6GEYJ103	S.M.CARB	0.1W	5%	10K Ω
R263	ERJ6GEYJ104	S.M.CARB	0.1W	5%	100K Ω
R264	ERJ6GEYJ473	S.M.CARB	0.1W	5%	47K Ω
R265	ERDS1TJ2R2	CARBON	0.5W	5%	2R2 Ω

Cct Ref	Parts Number	Description			
R266	ERDS1TJ2R2	CARBON	0.5W	5%	2R2 Ω
R269	ERJ6GEYJ273	S.M.CARB	0.1W	5%	27K Ω
R270	ERJ6GEYJ273	S.M.CARB	0.1W	5%	27K Ω
R271	ERJ6GEYJ272	S.M.CARB	0.1W	5%	2K7 Ω
R272	ERJ6GEYJ103	S.M.CARB	0.1W	5%	10K Ω
R273	ERJ6GEYJ331	S.M.CARB	0.1W	5%	330 Ω
R299	ERD25TJ225	CARBON	0.25W	5%	2M2 Ω
R350	ERQ12AJ331P	METAL	.125W	5%	330 Ω ▲
R351	ERJ6GEYJ911	S.M.CARB	0.1W	5%	910 Ω
R352	ERJ6GEYJ102	S.M.CARB	0.1W	5%	1K Ω
R354	ERO25CKF4122	METAL	0.25W	5%	1K2 Ω ▲
R355	ERG2FG823H	METAL	2W	5%	82K Ω ▲
R356	ERJ6GEY0R00	S.M.CARB	0.1W	5%	0 Ω
R357	ERJ6GEY0R00	S.M.CARB	0.1W	5%	0 Ω
R358	ERC12GK471C	SOLID	0.5W	5%	470 Ω
R360	ERO50PKF8251	METAL	0.5W	5%	8M2 Ω ▲
R361	ERJ6GEYJ911	S.M.CARB	0.1W	5%	910 Ω
R362	ERJ6GEYJ102	S.M.CARB	0.1W	5%	1K Ω
R364	ERO25CKF4122	METAL	0.25W	5%	1K2 Ω ▲
R365	ERG2FG823H	METAL	2W	5%	82K Ω ▲
R366	ERJ6GEY0R00	S.M.CARB	0.1W	5%	0 Ω
R367	ERJ6GEY0R00	S.M.CARB	0.1W	5%	0 Ω
R368	ERC12GK471C	SOLID	0.5W	5%	470 Ω
R369	ERJ6GEY0R00	S.M.CARB	0.1W	5%	0 Ω
R370	ERQ2CJP2R2	METAL	2W	5%	2R2 Ω ▲
R371	ERJ6GEYJ911	S.M.CARB	0.1W	5%	910 Ω
R372	ERJ6GEYJ102	S.M.CARB	0.1W	5%	1K Ω
R374	ERO25CKF4122	METAL	0.25W	5%	1K2 Ω ▲
R375	ERG2FG823H	METAL	2W	5%	82K Ω ▲
R376	ERJ6GEY0R00	S.M.CARB	0.1W	5%	0 Ω
R377	ERJ6GEY0R00	S.M.CARB	0.1W	5%	0 Ω
R378	ERC12GK471C	SOLID	0.5W	5%	470 Ω
R379	ERJ6GEY0R00	S.M.CARB	0.1W	5%	0 Ω
R383	ERJ6GEY0R00	S.M.CARB	0.1W	5%	0 Ω
R391	ERJ6GEYJ821	S.M.CARB	0.1W	5%	820 Ω
R392	ERJ6GEYJ821	S.M.CARB	0.1W	5%	820 Ω
R393	ERJ6GEYJ821	S.M.CARB	0.1W	5%	820 Ω
R394	ERJ6ENF1021	S.M. CAR	0.1W	5%	1K Ω
R395	ERJ6ENF2370	S.M. CAR	0.1W	5%	37 Ω
R396	ERJ6ENF1021	S.M. CAR	0.1W	5%	1K Ω
R397	ERJ6ENF2370	S.M. CAR	0.1W	5%	37 Ω
R398	ERJ6ENF1021	S.M. CAR	0.1W	5%	1K Ω
R399	ERJ6ENF2370	S.M. CAR	0.1W	5%	37 Ω
R401	ERJ6GEYJ272	S.M.CARB	0.1W	5%	2K7 Ω
R402	ERJ6GEYJ682	S.M.CARB	0.1W	5%	6K8 Ω
R403	ERJ6GEYJ102	S.M.CARB	0.1W	5%	1K Ω
R404	ERJ6GEYJ103	S.M.CARB	0.1W	5%	10K Ω
R416	ERJ6GEYJ682	S.M.CARB	0.1W	5%	6K8 Ω
R418	ERJ6GEYJ682	S.M.CARB	0.1W	5%	6K8 Ω
R419	ERG3FJ471	METAL	3W	5%	470 Ω ▲
R420	ERJ6GEYJ563	S.M.CARB	0.1W	5%	56K Ω
R421	ERJ6GEYJ224	S.M.CARB	0.1W	5%	220K Ω
R441	ERJ6GEYJ393	S.M.CARB	0.1W	5%	39K Ω
R442	ERJ6GEYJ123	S.M.CARB	0.1W	5%	12K Ω
R451	ERDS1TJ3R3	CARBON	0.5W	5%	3R3 Ω
R452	ERDS1TJ3R3	CARBON	0.5W	5%	3R3 Ω
R453	ERJ6GEYJ393	S.M.CARB	0.1W	5%	39K Ω
R454	ERJ6GEYJ123	S.M.CARB	0.1W	5%	12K Ω
R457	ERJ6GEYJ682	S.M.CARB	0.1W	5%	6K8 Ω
R458	ERJ6GEYJ302	S.M.CARB	0.1W	5%	3K Ω
R470	ERJ6GEYJ682	S.M.CARB	0.1W	5%	6K8 Ω
R471	ERDS1FJ1R0	CARBON	0.5W	5%	1 Ω ▲
R504	ERD25TJ271	CARBON	0.25W	5%	270 Ω
R506	ERDS1TJ681	CARBON	0.5W	5%	680 Ω
R507	ERDS1TJ681	CARBON	0.5W	5%	680 Ω
R554	ERX3FJR33H	METAL	3W	5%	R33 Ω

Cct Ref	Parts Number	Description				
R556	ERDS1TJ223	CARBON	0.5W	5%	22K Ω	
R557	ERDS1TJ683	CARBON	0.5W	5%	68K Ω	
R558	ERDS1TJ273	CARBON	0.5W	5%	27K Ω	
R560	ERJ6GEYJ222	S.M.CARB	0.1W	5%	2K2 Ω	
R562	ERJ6GEYJ393	S.M.CARB	0.1W	5%	39K Ω	
R564	ERDS1TJ394	CARBON	0.5W	5%	390K Ω	
R567	ERG3FJ223	METAL	3W	5%	22K Ω	▲
R569	ERDS1TJ120	CARBON	0.5W	5%	12 Ω	
R570	ERJ6GEYJ103	S.M.CARB	0.1W	5%	10K Ω	
R572	ERG3FJ821	METAL	3W	5%	820 Ω	▲
R574	ERG3FJ151	METAL	3W	5%	150 Ω	▲
R579	ERJ6GEYJ274	S.M.CARB	0.1W	5%	270K Ω	
R580	ERJ6GEYJ563	S.M.CARB	0.1W	5%	56K Ω	
R581	ERJ6GEYJ104	S.M.CARB	0.1W	5%	100K Ω	
R582	ERJ6GEYJ225	S.M.CARB	0.1W	5%	2M2 Ω	
R583	ERJ6GEYJ225	S.M.CARB	0.1W	5%	2M2 Ω	
R588	ERJ6GEY0R00	S.M.CARB	0.1W	5%	0 Ω	
R601	ERJ6GEYJ153	S.M.CARB	0.1W	5%	15K Ω	
R613	ERJ6GEYJ101	S.M.CARB	0.1W	5%	100 Ω	
R614	ERJ6GEYJ101	S.M.CARB	0.1W	5%	100 Ω	
R615	ERJ6GEYJ101	S.M.CARB	0.1W	5%	100 Ω	
R616	ERJ6GEYJ100	S.M.CARB	0.1W	5%	10 Ω	
R617	ERJ6GEYJ102	S.M.CARB	0.1W	5%	1K Ω	
R619	ERJ6GEYJ101	S.M.CARB	0.1W	5%	100 Ω	
R620	ERJ6GEYJ101	S.M.CARB	0.1W	5%	100 Ω	
R622	ERJ6GEYJ393	S.M.CARB	0.1W	5%	39K Ω	
R623	ERJ6GEYJ153	S.M.CARB	0.1W	5%	15K Ω	
R626	ERJ6GEYJ331	S.M.CARB	0.1W	5%	330 Ω	
R627	ERJ6GEYJ102	S.M.CARB	0.1W	5%	1K Ω	
R628	ERJ6GEYJ472	S.M.CARB	0.1W	5%	4K7 Ω	
R630	ERJ6GEYJ103	S.M.CARB	0.1W	5%	10K Ω	
R631	ERJ6GEYJ105	S.M.CARB	0.1W	5%	1M Ω	
R632	ERJ6GEYJ223	S.M.CARB	0.1W	5%	22K Ω	
R634	ERJ6GEYJ103	S.M.CARB	0.1W	5%	10K Ω	
R635	ERJ6GEYJ101	S.M.CARB	0.1W	5%	100 Ω	
R636	ERJ6GEYJ101	S.M.CARB	0.1W	5%	100 Ω	
R637	ERJ6GEYJ101	S.M.CARB	0.1W	5%	100 Ω	
R638	ERJ6GEYJ101	S.M.CARB	0.1W	5%	100 Ω	
R639	ERJ6GEYJ101	S.M.CARB	0.1W	5%	100 Ω	
R640	ERJ6GEYJ101	S.M.CARB	0.1W	5%	100 Ω	
R641	ERJ6GEYJ101	S.M.CARB	0.1W	5%	100 Ω	
R642	ERJ6GEYJ102	S.M.CARB	0.1W	5%	1K Ω	
R643	ERJ6GEYJ102	S.M.CARB	0.1W	5%	1K Ω	
R644	ERJ6GEYJ102	S.M.CARB	0.1W	5%	1K Ω	
R645	ERJ6GEYJ102	S.M.CARB	0.1W	5%	1K Ω	
R646	ERJ6GEYJ821	S.M.CARB	0.1W	5%	820 Ω	
R647	ERJ6GEYJ101	S.M.CARB	0.1W	5%	100 Ω	
R648	ERJ6GEYJ101	S.M.CARB	0.1W	5%	100 Ω	
R649	ERJ6GEYJ101	S.M.CARB	0.1W	5%	100 Ω	
R650	ERJ6GEYJ101	S.M.CARB	0.1W	5%	100 Ω	
R651	ERJ6GEYJ101	S.M.CARB	0.1W	5%	100 Ω	
R652	ERJ6GEYJ101	S.M.CARB	0.1W	5%	100 Ω	
R653	ERJ6GEYJ101	S.M.CARB	0.1W	5%	100 Ω	
R655	ERJ6GEYJ224	S.M.CARB	0.1W	5%	220K Ω	
R657	ERJ6GEYJ750	S.M.CARB	0.1W	5%	75 Ω	
R658	ERJ6ENF2212	S.M. CAR	0.1W	5%	220 Ω	
R663	ERJ6GEYJ474	S.M.CARB	0.1W	5%	470K Ω	
R664	ERJ6GEYJ682	S.M.CARB	0.1W	5%	6K8 Ω	
R666	ERJ6GEYJ222	S.M.CARB	0.1W	5%	2K2 Ω	
R667	ERJ6GEYJ273	S.M.CARB	0.1W	5%	27K Ω	
R668	ERJ6GEYJ184	S.M.CARB	0.1W	5%	180K Ω	
R674	ERJ6GEYJ273	S.M.CARB	0.1W	5%	27K Ω	
R675	ERJ6GEYJ562	S.M.CARB	0.1W	5%	5K6 Ω	
R676	ERJ6GEYJ103	S.M.CARB	0.1W	5%	10K Ω	
R677	ERJ6GEYJ273	S.M.CARB	0.1W	5%	27K Ω	
R678	ERJ6GEYJ562	S.M.CARB	0.1W	5%	5K6 Ω	

Cct Ref	Parts Number	Description				
R679	ERJ6GEYJ103	S.M.CARB	0.1W	5%	10K Ω	
R680	ERJ6GEYJ273	S.M.CARB	0.1W	5%	27K Ω	
R681	ERJ6GEYJ103	S.M.CARB	0.1W	5%	10K Ω	
R682	ERJ6GEYJ103	S.M.CARB	0.1W	5%	10K Ω	
R683	ERJ6GEYJ103	S.M.CARB	0.1W	5%	10K Ω	
R684	ERJ6GEYJ101	S.M.CARB	0.1W	5%	100 Ω	
R685	ERJ6GEYJ103	S.M.CARB	0.1W	5%	10K Ω	
R686	ERJ6GEYJ102	S.M.CARB	0.1W	5%	1K Ω	
R688	ERJ6ENF3162	S.M. CAR	0.1W	5%	1K6 Ω	
R701	ERQ1CJP5R6	METAL	1W	5%	5R6 Ω	▲
R702	ERDS1TJ913	CARBON	0.5W	5%	91K Ω	
R703	ERJ6GEYJ123	S.M.CARB	0.1W	5%	12K Ω	
R704	ERDS1TJ330	CARBON	0.5W	5%	33 Ω	
R705	ERJ6GEYJ472	S.M.CARB	0.1W	5%	4K7 Ω	
R805	ERD25TC0T	CARBON	0.25W	5%	0 Ω	
R806	ERJ6GEYJ101	S.M.CARB	0.1W	5%	100 Ω	
R807	ERD25TJ104	CARBON	0.25W	5%	100K Ω	
R809	ERF10ZK4R7	WOUND	10W	5%	4R7 Ω	▲
R810	ERJ6GEYJ223	S.M.CARB	0.1W	5%	22K Ω	
R811	ERJ6GEYJ391	S.M.CARB	0.1W	5%	390 Ω	
R812	ERD25TJ681	CARBON	0.25W	5%	680 Ω	
R814	ERD25TJ392	CARBON	0.25W	5%	3K9 Ω	
R815	ERD25TJ100	CARBON	0.25W	5%	10 Ω	
R816	ERDS1TJ330	CARBON	0.5W	5%	33 Ω	
R818	ERJ6GEYJ271	S.M.CARB	0.1W	5%	270 Ω	
R820	ERG3FJ223	METAL	3W	5%	22K Ω	▲
R821	ERG3FJ223	METAL	3W	5%	22K Ω	▲
R822	ERD25TJ391	CARBON	0.25W	5%	390 Ω	
R823	ERX12SJR22	METAL	0.5W	5%	R22 Ω	
R824	ERX12SJR22	METAL	0.5W	5%	R22 Ω	
R825	ERX12SJR22	METAL	0.5W	5%	R22 Ω	
R827	ERDS1FJ121	CARBON	0.5W	5%	120 Ω	▲
R828	ERD25TJ103	CARBON	0.25W	5%	10K Ω	
R829	ERD25TJ221	CARBON	0.25W	5%	220 Ω	
R830	ERX12SJR22	METAL	0.5W	5%	R22 Ω	
R831	ERD75TAJ825	CARBON	0.75W	5%	8M2 Ω	▲
R832	ERG3FJ331	METAL	3W	5%	330 Ω	▲
R835	ERD25TJ220	CARBON	0.25W	5%	22 Ω	
R836	ERD25TJ100	CARBON	0.25W	5%	10 Ω	
R837	ERD25TJ183	CARBON	0.25W	5%	18K Ω	
R838	ERD25TJ821	CARBON	0.25W	5%	820 Ω	
R841	ERC12ZGK105D	SOLID	0.5W	10%	1M Ω	
R857	ERD25TJ221	CARBON	0.25W	5%	220 Ω	
R862	ERD25TJ272	CARBON	0.25W	5%	2K7 Ω	
R863	ERG3FJ680H	METAL	3W	5%	68 Ω	▲
R864	ERDS1TJ682	CARBON	0.5W	5%	6K8 Ω	
R867	ERD25TJ102	CARBON	0.25W	5%	1K Ω	
R868	ERD25TJ151	CARBON	0.25W	5%	150 Ω	
R869	ERD25TJ560	CARBON	0.25W	5%	56 Ω	
R870	ERJ6GEYJ101	S.M.CARB	0.1W	5%	100 Ω	
R872	ERJ6GEY0R00	S.M.CARB	0.1W	5%	0 Ω	
R873	ERQ2CJP2R4	METAL	2W	5%	2R4 Ω	▲
R876	ERJ6GEYJ562	S.M.CARB	0.1W	5%	5K6 Ω	
R877	ERO25CKF1022	METAL	0.25W	1%	10K2 Ω	▲
R878	ERO25CKF1002	METAL	0.25W	1%	10K Ω	▲
R883	ERJ6GEYJ103	S.M.CARB	0.1W	5%	10K Ω	
R885	ERD25TJ103	CARBON	0.25W	5%	10K Ω	
R886	ERX3SJR47P	METAL	3W	5%	R47 Ω	
R888	ERDS1TJ393	CARBON	0.5W	5%	39K Ω	
R889	ERJ6GEYJ392	S.M.CARB	0.1W	5%	3K9 Ω	
R891	ERJ6GEYJ103	S.M.CARB	0.1W	5%	10K Ω	
R892	ERJ6GEYJ222	S.M.CARB	0.1W	5%	2K2 Ω	
R894	ERJ6GEY0R00	S.M.CARB	0.1W	5%	0 Ω	
R897	ERJ6GEYJ183	S.M.CARB	0.1W	5%	18K Ω	
R899	ERJ6GEY0R00	S.M.CARB	0.1W	5%	0 Ω	
R901	ERJ6GEYJ562	S.M.CARB	0.1W	5%	5K6 Ω	

Cct Ref	Parts Number	Description				
R902	ERJ6GEYJ562	S.M.CARB	0.1W	5%	5K6 Ω	
R903	ERJ6GEYJ562	S.M.CARB	0.1W	5%	5K6 Ω	
R904	ERJ6GEYJ102	S.M.CARB	0.1W	5%	1K Ω	
R906	ERJ6GEYJ153	S.M.CARB	0.1W	5%	15K Ω	
R907	ERJ6GEYJ222	S.M.CARB	0.1W	5%	2K2 Ω	
R908	ERJ6GEYJ471	S.M.CARB	0.1W	5%	470 Ω	
R909	ERJ6GEYJ222	S.M.CARB	0.1W	5%	2K2 Ω	
R910	ERJ6GEYJ101	S.M.CARB	0.1W	5%	100 Ω	
R911	ERD25TJ561	CARBON	0.25W	5%	560 Ω	
R913	ERJ6GEYJ183	S.M.CARB	0.1W	5%	18K Ω	
R914	ERJ6GEYJ202	S.M.CARB	0.1W	5%	2K Ω	
R915	ERJ6GEYJ182	S.M.CARB	0.1W	5%	1K8 Ω	
R916	ERJ6GEYJ221	S.M.CARB	0.1W	5%	220 Ω	
R919	ERQ14AJW390	FUSIBLE	0.25W	5%	39 Ω	△
R920	ERQ14AJW390	FUSIBLE	0.25W	5%	39 Ω	△
R922	ERD25TJ683	CARBON	0.25W	5%	68K Ω	
R923	ERD25TJ683	CARBON	0.25W	5%	68K Ω	
R924	ERDS1FYJ390	CARBON	0.5W	5%	39 Ω	△
R925	ERJ6GEY0R00	S.M.CARB	0.1W	5%	0 Ω	
R926	ERJ6GEY0R00	S.M.CARB	0.1W	5%	0 Ω	
R927	ERD25TJ122	CARBON	0.25W	5%	1K2 Ω	
R928	ERD25TJ6R8	CARBON	0.25W	5%	6R8 Ω	
R929	ERDS1FYJ471	CARBON	0.5W	5%	470 Ω	△
R931	ERDS1FYJ390	CARBON	0.5W	5%	39 Ω	△
R935	ERQ14AJW3R9	FUSIBLE	0.25W	5%	3R9 Ω	△
R936	ERQ1CJP102	FUSIBLE	1W	5%	1K Ω	△
R937	ERQ14AJW100	FUSIBLE	0.25W	5%	10 Ω	△
R938	ERD25TJ122	CARBON	0.25W	5%	1K2 Ω	
R939	ERJ6GEY0R00	S.M.CARB	0.1W	5%	0 Ω	
R941	ERD25TJ6R8	CARBON	0.25W	5%	6R8 Ω	
R1011	ERD25TJ101	CARBON	0.25W	5%	100 Ω	
R1012	ERD25TJ101	CARBON	0.25W	5%	100 Ω	
R1013	ERD25TJ471	CARBON	0.25W	5%	470 Ω	
R1015	ERD25TJ103	CARBON	0.25W	5%	10K Ω	
R1071	ERD25TJ103	CARBON	0.25W	5%	10K Ω	
R1072	ERD25TJ222	CARBON	0.25W	5%	2K2 Ω	
R1073	ERD25TJ222	CARBON	0.25W	5%	2K2 Ω	
R1074	ERD25TJ332	CARBON	0.25W	5%	3K3 Ω	
R1075	ERD25TJ512	CARBON	0.25W	5%	5K1 Ω	
R1076	ERD25TJ912	CARBON	0.25W	5%	9K1 Ω	
R1101	ERJ6GEYJ101	S.M.CARB	0.1W	5%	100 Ω	
R1103	ERJ6GEYJ472	S.M.CARB	0.1W	5%	4K7 Ω	
R1104	ERJ6GEYJ101	S.M.CARB	0.1W	5%	100 Ω	
R1105	ERJ6GEYJ101	S.M.CARB	0.1W	5%	100 Ω	
R1106	ERJ6GEYJ472	S.M.CARB	0.1W	5%	4K7 Ω	
R1107	ERJ6GEYJ101	S.M.CARB	0.1W	5%	100 Ω	
R1108	ERJ6GEYJ472	S.M.CARB	0.1W	5%	4K7 Ω	
R1109	ERJ6GEYJ101	S.M.CARB	0.1W	5%	100 Ω	
R1110	ERJ6GEYJ101	S.M.CARB	0.1W	5%	100 Ω	
R1111	ERJ6GEYJ101	S.M.CARB	0.1W	5%	100 Ω	
R1112	ERJ6GEYJ103	S.M.CARB	0.1W	5%	10K Ω	
R1113	ERJ6GEYJ101	S.M.CARB	0.1W	5%	100 Ω	
R1114	ERJ6GEYJ101	S.M.CARB	0.1W	5%	100 Ω	
R1116	ERJ6GEYJ101	S.M.CARB	0.1W	5%	100 Ω	
R1117	ERJ6GEYJ332	S.M.CARB	0.1W	5%	3K3 Ω	
R1118	ERJ6GEYJ332	S.M.CARB	0.1W	5%	3K3 Ω	
R1119	ERJ6GEYJ332	S.M.CARB	0.1W	5%	3K3 Ω	
R1120	ERJ6GEYJ332	S.M.CARB	0.1W	5%	3K3 Ω	
R1121	ERJ6GEYJ472	S.M.CARB	0.1W	5%	4K7 Ω	
R1122	ERJ6GEYJ472	S.M.CARB	0.1W	5%	4K7 Ω	
R1123	ERJ6GEYJ823	S.M.CARB	0.1W	5%	82K Ω	
R1124	ERJ6GEYJ101	S.M.CARB	0.1W	5%	100 Ω	
R1125	ERJ6GEYJ101	S.M.CARB	0.1W	5%	100 Ω	
R1126	ERJ6GEYJ101	S.M.CARB	0.1W	5%	100 Ω	
R1127	ERJ6GEYJ101	S.M.CARB	0.1W	5%	100 Ω	
R1128	ERJ6GEYJ472	S.M.CARB	0.1W	5%	4K7 Ω	

Cct Ref	Parts Number	Description				
R1129	ERJ6GEYJ472	S.M.CARB	0.1W	5%	4K7 Ω	
R1130	ERJ6GEYJ104	S.M.CARB	0.1W	5%	100K Ω	
R1131	ERJ6GEYJ101	S.M.CARB	0.1W	5%	100 Ω	
R1132	ERJ6GEYJ101	S.M.CARB	0.1W	5%	100 Ω	
R1133	ERJ6GEYJ101	S.M.CARB	0.1W	5%	100 Ω	
R1134	ERJ6GEYJ101	S.M.CARB	0.1W	5%	100 Ω	
R1135	ERJ6GEYJ225	S.M.CARB	0.1W	5%	2M2 Ω	
R1138	ERJ6GEYJ273	S.M.CARB	0.1W	5%	27K Ω	
R1139	ERJ6GEYJ472	S.M.CARB	0.1W	5%	4K7 Ω	
R1140	ERJ6GEYJ392	S.M.CARB	0.1W	5%	3K9 Ω	
R1141	ERJ6GEYJ103	S.M.CARB	0.1W	5%	10K Ω	
R1142	ERJ6GEYJ103	S.M.CARB	0.1W	5%	10K Ω	
R1143	ERJ6GEYJ101	S.M.CARB	0.1W	5%	100 Ω	
R1144	ERJ6GEYJ473	S.M.CARB	0.1W	5%	47K Ω	
R1145	ERJ6GEYJ472	S.M.CARB	0.1W	5%	4K7 Ω	
R1146	ERJ6GEYJ101	S.M.CARB	0.1W	5%	100 Ω	
R1147	ERJ6GEYJ223	S.M.CARB	0.1W	5%	22K Ω	
R1148	ERJ6GEYJ104	S.M.CARB	0.1W	5%	100K Ω	
R1149	ERJ6GEYJ104	S.M.CARB	0.1W	5%	100K Ω	
R1150	ERJ6GEYJ104	S.M.CARB	0.1W	5%	100K Ω	
R1151	ERJ6GEYJ103	S.M.CARB	0.1W	5%	10K Ω	
R1152	ERJ6GEYJ224	S.M.CARB	0.1W	5%	220K Ω	
R1153	ERJ6GEYJ273	S.M.CARB	0.1W	5%	27K Ω	
R1154	ERJ6GEYJ221	S.M.CARB	0.1W	5%	220 Ω	
R1155	ERJ6GEYJ474	S.M.CARB	0.1W	5%	470K Ω	
R1156	ERJ6GEY0R00	S.M.CARB	0.1W	5%	0 Ω	
R1157	ERJ6GEYJ100	S.M.CARB	0.1W	5%	10 Ω	
R1158	ERJ6GEYJ472	S.M.CARB	0.1W	5%	4K7 Ω	
R1160	ERJ6GEY0R00	S.M.CARB	0.1W	5%	0 Ω	
R1161	ERJ6GEYJ392	S.M.CARB	0.1W	5%	3K9 Ω	
R1162	ERJ6GEYJ102	S.M.CARB	0.1W	5%	1K Ω	
R1163	ERJ6GEYJ103	S.M.CARB	0.1W	5%	10K Ω	
R1164	ERJ6GEYJ103	S.M.CARB	0.1W	5%	10K Ω	
R1165	ERJ6GEYJ103	S.M.CARB	0.1W	5%	10K Ω	
R1166	ERJ6GEYJ683	S.M.CARB	0.1W	5%	68K Ω	
R1167	ERJ6GEYJ103	S.M.CARB	0.1W	5%	10K Ω	
R1168	ERJ6GEYJ103	S.M.CARB	0.1W	5%	10K Ω	
R1169	ERJ6GEYJ103	S.M.CARB	0.1W	5%	10K Ω	
R1170	ERJ6GEYJ472	S.M.CARB	0.1W	5%	4K7 Ω	
R1171	ERJ6GEYJ472	S.M.CARB	0.1W	5%	4K7 Ω	
R1172	ERJ6GEYJ821	S.M.CARB	0.1W	5%	820 Ω	
R1173	ERJ6GEYJ681	S.M.CARB	0.1W	5%	680 Ω	
R1174	ERJ6GEYJ681	S.M.CARB	0.1W	5%	680 Ω	
R1175	ERJ6GEYJ101	S.M.CARB	0.1W	5%	100 Ω	
R1176	ERJ6GEYJ101	S.M.CARB	0.1W	5%	100 Ω	
R1177	ERJ6GEYJ103	S.M.CARB	0.1W	5%	10K Ω	
R1178	ERJ6GEYJ103	S.M.CARB	0.1W	5%	10K Ω	
R1179	ERJ6GEYJ101	S.M.CARB	0.1W	5%	100 Ω	
R1180	ERJ6GEYJ472	S.M.CARB	0.1W	5%	4K7 Ω	
R1181	ERJ6GEYJ101	S.M.CARB	0.1W	5%	100 Ω	
R1182	ERJ6GEYJ472	S.M.CARB	0.1W	5%	4K7 Ω	
R1183	ERJ6GEYJ472	S.M.CARB	0.1W	5%	4K7 Ω	
R1184	ERJ6GEYJ101	S.M.CARB	0.1W	5%	100 Ω	
R1186	ERJ6GEYJ103	S.M.CARB	0.1W	5%	10K Ω	
R1187	ERJ6GEYJ103	S.M.CARB	0.1W	5%	10K Ω	
R1188	ERJ6GEYJ472	S.M.CARB	0.1W	5%	4K7 Ω	
R1189	ERJ6GEYJ101	S.M.CARB	0.1W	5%	100 Ω	
R1190	ERJ6GEYJ472	S.M.CARB	0.1W	5%	4K7 Ω	
R1194	ERJ6GEYJ681	S.M.CARB	0.1W	5%	680 Ω	
R1195	ERJ6GEYJ103	S.M.CARB	0.1W	5%	10K Ω	
R1200	ERJ6GEYJ472	S.M.CARB	0.1W	5%	4K7 Ω	
R1237	ERJ6GEY0R00	S.M.CARB	0.1W	5%	0 Ω	
R1238	ERJ6GEYJ102	S.M.CARB	0.1W	5%	1K Ω	
R1239	ERJ6GEYJ560	S.M.CARB	0.1W	5%	56 Ω	
R1501	ERJ6GEY0R00	S.M.CARB	0.1W	5%	0 Ω	
R1502	ERJ6GEYJ151	S.M.CARB	0.1W	5%	150 Ω	

Cct Ref	Parts Number	Description				
R1503	ERJ6GEYJ332	S.M.CARB	0.1W	5%	3K3	Ω
R1504	ERJ6GEYJ151	S.M.CARB	0.1W	5%	150	Ω
R1505	ERJ6GEYJ471	S.M.CARB	0.1W	5%	470	Ω
R1506	ERJ6GEYJ271	S.M.CARB	0.1W	5%	270	Ω
R1507	ERJ6GEYJ102	S.M.CARB	0.1W	5%	1K	Ω
R1508	ERJ6GEYJ471	S.M.CARB	0.1W	5%	470	Ω
R1509	ERJ6GEYJ471	S.M.CARB	0.1W	5%	470	Ω
R1510	ERJ6GEYJ8R2	S.M. CAR	0.1W	5%	8R2	Ω
R1511	ERJ6GEYJ101	S.M.CARB	0.1W	5%	100	Ω
R1513	ERJ6GEYJ101	S.M.CARB	0.1W	5%	100	Ω
R1514	ERJ6GEYJ180	S.M.CARB	0.1W	5%	18	Ω
R1515	ERJ6GEYJ101	S.M.CARB	0.1W	5%	100	Ω
R1517	ERJ6GEYJ180	S.M.CARB	0.1W	5%	18	Ω
R1518	ERJ6GEYJ180	S.M.CARB	0.1W	5%	18	Ω
R1519	ERJ6GEYJ561	S.M.CARB	0.1W	5%	560	Ω
R1520	ERJ6GEYJ471	S.M.CARB	0.1W	5%	470	Ω
R1521	ERJ6GEYJ820	S.M.CARB	0.1W	5%	82	Ω
R1522	ERJ6GEYJ302	S.M.CARB	0.1W	5%	3K	Ω
R1523	ERJ6GEYJ390	S.M.CARB	0.1W	5%	39	Ω
R1524	ERJ6GEYJ560	S.M.CARB	0.1W	5%	56	Ω
R1525	ERJ6GEYJ271	S.M.CARB	0.1W	5%	270	Ω
R1526	ERJ6GEY0R00	S.M.CARB	0.1W	5%	0	Ω
R1527	ERJ6GEYJ100	S.M.CARB	0.1W	5%	10	Ω
R1528	ERJ6GEYJ151	S.M.CARB	0.1W	5%	150	Ω
R1530	ERJ6GEYJ560	S.M.CARB	0.1W	5%	56	Ω
R1531	ERJ6GEYJ151	S.M.CARB	0.1W	5%	150	Ω
R1532	ERJ6GEYJ151	S.M.CARB	0.1W	5%	150	Ω
R1533	ERJ6GEYJ181	S.M.CARB	0.1W	5%	180	Ω
R1534	ERJ6GEYJ272	S.M.CARB	0.1W	5%	2K7	Ω
R1535	ERJ6GEYJ103	S.M.CARB	0.1W	5%	10K	Ω
R1536	ERJ6GEYJ470	S.M.CARB	0.1W	5%	47	Ω
R1537	ERJ6GEYJ103	S.M.CARB	0.1W	5%	10K	Ω
R1538	ERJ6GEYJ181	S.M.CARB	0.1W	5%	180	Ω
R1540	ERJ6GEYJ102	S.M.CARB	0.1W	5%	1K	Ω
R1541	ERJ6GEYJ102	S.M.CARB	0.1W	5%	1K	Ω
R1542	ERJ6GEYJ151	S.M.CARB	0.1W	5%	150	Ω
R1543	ERJ6GEYJ103	S.M.CARB	0.1W	5%	10K	Ω
R1544	ERJ6GEYJ561	S.M.CARB	0.1W	5%	560	Ω
R1545	ERJ6ENF3600	S.M. CAR	0.1W	5%	36	Ω
R1546	ERJ6GEYJ561	S.M.CARB	0.1W	5%	560	Ω
R1547	ERJ6GEYJ103	S.M.CARB	0.1W	5%	10K	Ω
R1548	ERJ6GEYJ221	S.M.CARB	0.1W	5%	220	Ω
R1550	ERJ6GEYJ103	S.M.CARB	0.1W	5%	10K	Ω
R1551	ERJ6GEYJ271	S.M.CARB	0.1W	5%	270	Ω
R1552	ERJ6GEYJ103	S.M.CARB	0.1W	5%	10K	Ω
R1553	ERJ6GEYJ750	S.M.CARB	0.1W	5%	75	Ω
R1554	ERJ6GEYJ101	S.M.CARB	0.1W	5%	100	Ω
R1555	ERJ6GEYJ101	S.M.CARB	0.1W	5%	100	Ω
R1556	ERJ6GEYJ101	S.M.CARB	0.1W	5%	100	Ω
R1559	ERJ6ENF2200	S.M. CAR	0.1W	5%	22	Ω
R1560	ERJ6GEYJ560	S.M.CARB	0.1W	5%	56	Ω
R1561	ERJ6GEY0R00	S.M.CARB	0.1W	5%	0	Ω
R1562	ERJ6ENF4750	S.M. CAR	0.1W	5%	75	Ω
R1563	ERJ6GEYJ271	S.M.CARB	0.1W	5%	270	Ω
R1564	ERJ6ENF2200	S.M. CAR	0.1W	5%	22	Ω
R1565	ERJ6GEYJ820	S.M.CARB	0.1W	5%	82	Ω
R1566	ERJ6GEYJ331	S.M.CARB	0.1W	5%	330	Ω
R1567	ERJ6ENF1500	S.M. CAR	0.1W	5%	15	Ω
R1568	ERJ6ENF1500	S.M. CAR	0.1W	5%	15	Ω
R1569	ERJ6ENF1500	S.M. CAR	0.1W	5%	15	Ω
R1570	ERJ6ENF2701	S.M.CARB	0.1W	5%	27	Ω
R1571	ERJ6GEYJ103	S.M.CARB	0.1W	5%	10K	Ω
R1572	ERJ6GEYJ103	S.M.CARB	0.1W	5%	10K	Ω
R1573	ERJ6ENF1500	S.M. CAR	0.1W	5%	15	Ω
R1574	ERJ6GEYJ560	S.M.CARB	0.1W	5%	56	Ω
R1575	ERJ6GEYJ102	S.M.CARB	0.1W	5%	1K	Ω

Cct Ref	Parts Number	Description				
R1576	ERJ6GEYJ102	S.M.CARB	0.1W	5%	1K	Ω
R1577	ERJ6GEYJ102	S.M.CARB	0.1W	5%	1K	Ω
R1578	ERJ6GEYJ301	S.M.CARB	0.1W	5%	300	Ω
R1579	ERJ6GEYJ431	S.M.CARB	0.1W	5%	430	Ω
R1580	ERJ6GEYJ511	S.M.CARB	0.1W	5%	510	Ω
R1581	ERJ6GEYJ151	S.M.CARB	0.1W	5%	150	Ω
R1582	ERJ6GEYJ103	S.M.CARB	0.1W	5%	10K	Ω
R1583	ERJ6GEYJ561	S.M.CARB	0.1W	5%	560	Ω
R1584	ERJ6GEYJ561	S.M.CARB	0.1W	5%	560	Ω
R1585	ERJ6GEYJ103	S.M.CARB	0.1W	5%	10K	Ω
R1586	ERJ6GEY0R00	S.M.CARB	0.1W	5%	0	Ω
R1587	ERJ6GEY0R00	S.M.CARB	0.1W	5%	0	Ω
R1588	ERJ6GEYJ221	S.M.CARB	0.1W	5%	220	Ω
R1589	ERJ6GEYJ152	S.M.CARB	0.1W	5%	1K5	Ω
R1590	ERJ6GEYJ101	S.M.CARB	0.1W	5%	100	Ω
R1591	ERJ6GEYJ103	S.M.CARB	0.1W	5%	10K	Ω
R1592	ERJ6GEYJ101	S.M.CARB	0.1W	5%	100	Ω
R1593	ERJ6GEYJ101	S.M.CARB	0.1W	5%	100	Ω
R1594	ERJ6GEYJ101	S.M.CARB	0.1W	5%	100	Ω
R1595	ERJ6GEYJ101	S.M.CARB	0.1W	5%	100	Ω
R1598	ERJ6GEYJ101	S.M.CARB	0.1W	5%	100	Ω
R1599	ERJ6GEYJ101	S.M.CARB	0.1W	5%	100	Ω
R1600	ERJ6GEYJ103	S.M.CARB	0.1W	5%	10K	Ω
R1603	ERJ6GEYJ101	S.M.CARB	0.1W	5%	100	Ω
R1604	ERJ6GEYJ820	S.M.CARB	0.1W	5%	82	Ω
R1605	ERJ6GEYJ183	S.M.CARB	0.1W	5%	18K	Ω
R1606	ERJ6GEYJ273	S.M.CARB	0.1W	5%	27K	Ω
R1607	ERJ6GEYJ101	S.M.CARB	0.1W	5%	100	Ω
R1609	ERJ6GEYJ103	S.M.CARB	0.1W	5%	10K	Ω
R1610	ERJ6GEYJ101	S.M.CARB	0.1W	5%	100	Ω
R1611	ERJ6GEYJ101	S.M.CARB	0.1W	5%	100	Ω
R1613	ERJ6GEYJ102	S.M.CARB	0.1W	5%	1K	Ω
R1614	ERJ6GEY0R00	S.M.CARB	0.1W	5%	0	Ω
R1615	ERJ6GEY0R00	S.M.CARB	0.1W	5%	0	Ω
R1616	ERJ6GEYJ101	S.M.CARB	0.1W	5%	100	Ω
R1617	ERJ6ENF1100	S.M. CAR	0.1W	5%	10	Ω
R1618	ERJ6GEYJ103	S.M.CARB	0.1W	5%	10K	Ω
R1619	ERJ6GEYJ103	S.M.CARB	0.1W	5%	10K	Ω
R1620	ERJ6GEYJ331	S.M.CARB	0.1W	5%	330	Ω
R1621	ERJ6GEYJ471	S.M.CARB	0.1W	5%	470	Ω
R1622	ERJ6GEYJ102	S.M.CARB	0.1W	5%	1K	Ω
R1623	ERJ6GEYJ471	S.M.CARB	0.1W	5%	470	Ω
R1624	ERJ6GEYJ333	S.M.CARB	0.1W	5%	33K	Ω
R1625	ERJ6GEYJ221	S.M.CARB	0.1W	5%	220	Ω
R1626	ERJ6GEYJ332	S.M.CARB	0.1W	5%	3K3	Ω
R1627	ERJ6GEYJ100	S.M.CARB	0.1W	5%	10	Ω
R1628	ERJ6GEY0R00	S.M.CARB	0.1W	5%	0	Ω
R1629	ERJ6GEYJ121	S.M.CARB	0.1W	5%	120	Ω
R1630	ERJ6GEYJ103	S.M.CARB	0.1W	5%	10K	Ω
R1631	ERJ6ENF1500	S.M. CAR	0.1W	5%	15	Ω
R1632	ERJ6GEY0R00	S.M.CARB	0.1W	5%	0	Ω
R1633	ERJ6GEY0R00	S.M.CARB	0.1W	5%	0	Ω
R1634	ERJ6GEYJ101	S.M.CARB	0.1W	5%	100	Ω
R1635	ERJ6GEYJ271	S.M.CARB	0.1W	5%	270	Ω
R1636	ERJ6GEYJ101	S.M.CARB	0.1W	5%	100	Ω
R1637	ERJ6GEYJ271	S.M.CARB	0.1W	5%	270	Ω
R1639	ERJ6GEYJ331	S.M.CARB	0.1W	5%	330	Ω
R1640	ERJ6GEY0R00	S.M.CARB	0.1W	5%	0	Ω
R1641	ERJ6GEYJ473	S.M.CARB	0.1W	5%	47K	Ω
R1642	ERJ6GEYJ183	S.M.CARB	0.1W	5%	18K	Ω
R1643	ERJ6GEYJ473	S.M.CARB	0.1W	5%	47K	Ω
R1644	ERJ6GEYJ183	S.M.CARB	0.1W	5%	18K	Ω
R1645	ERJ6GEYJ473	S.M.CARB	0.1W	5%	47K	Ω
R1646	ERJ6GEYJ183	S.M.CARB	0.1W	5%	18K	Ω
R1660	ERJ6GEYJ103	S.M.CARB	0.1W	5%	10K	Ω
R1661	ERJ6GEYJ471	S.M.CARB	0.1W	5%	470	Ω



Cct Ref	Parts Number	Description				
R1662	ERJ6GEYJ223	S.M.CARB	0.1W	5%	22K Ω	
R1663	ERJ6GEYJ331	S.M.CARB	0.1W	5%	330 Ω	
R1664	ERJ6GEYJ103	S.M.CARB	0.1W	5%	10K Ω	
R1665	ERJ6GEYJ471	S.M.CARB	0.1W	5%	470 Ω	
R1666	ERJ6GEYJ223	S.M.CARB	0.1W	5%	22K Ω	
R1667	ERJ6GEYJ331	S.M.CARB	0.1W	5%	330 Ω	
R1668	ERJ6GEYJ103	S.M.CARB	0.1W	5%	10K Ω	
R1669	ERJ6GEYJ471	S.M.CARB	0.1W	5%	470 Ω	
R1670	ERJ6GEYJ223	S.M.CARB	0.1W	5%	22K Ω	
R1671	ERJ6GEYJ331	S.M.CARB	0.1W	5%	330 Ω	
R1672	ERJ6GEYJ471	S.M.CARB	0.1W	5%	470 Ω	
R1673	ERJ6GEY0R00	S.M.CARB	0.1W	5%	0 Ω	
R1674	ERJ6GEY0R00	S.M.CARB	0.1W	5%	0 Ω	
R1675	ERJ6GEY0R00	S.M.CARB	0.1W	5%	0 Ω	
R1676	ERJ6GEYJ560	S.M.CARB	0.1W	5%	56 Ω	
R1677	ERJ6ENF6800	S.M. CAR	0.1W	5%	80 Ω	
R1678	ERJ6ENF1500	S.M. CAR	0.1W	5%	15 Ω	
R1679	ERJ6ENF1500	S.M. CAR	0.1W	5%	15 Ω	
R1680	ERJ6GEYJ271	S.M.CARB	0.1W	5%	270 Ω	
R1681	ERJ6GEYJ271	S.M.CARB	0.1W	5%	270 Ω	
R1682	ERJ6GEYJ271	S.M.CARB	0.1W	5%	270 Ω	
R1683	ERJ6GEYJ271	S.M.CARB	0.1W	5%	270 Ω	
R1684	ERJ6GEYJ271	S.M.CARB	0.1W	5%	270 Ω	
R1685	ERQ14AJ100	FUSIBLE	0.25W	5%	10 Ω	△
R1686	ERJ6GEYJ103	S.M.CARB	0.1W	5%	10K Ω	
R1687	ERJ6GEYJ103	S.M.CARB	0.1W	5%	10K Ω	
R1688	ERJ6GEYJ331	S.M.CARB	0.1W	5%	330 Ω	
R1690	ERJ6ENF75R0	S.M.CARB	0.5W	5%	75 Ω	
R1691	ERJ6ENF75R0	S.M.CARB	0.5W	5%	75 Ω	
R1692	ERJ6ENF75R0	S.M.CARB	0.5W	5%	75 Ω	
R1901	ERX2SJ4R7	METAL	2W	5%	4R7 Ω	
R1902	ERX2SJ4R7	METAL	2W	5%	4R7 Ω	
R1903	ERJ6GEYJ683	S.M.CARB	0.1W	5%	68K Ω	
R1904	ERJ6GEYJ334	S.M.CARB	0.1W	5%	330K Ω	
R1905	ERJ6GEYJ683	S.M.CARB	0.1W	5%	68K Ω	
R1906	ERJ6GEYJ563	S.M.CARB	0.1W	5%	56K Ω	
R1907	ERJ6GEY0R00	S.M.CARB	0.1W	5%	0 Ω	
R1908	ERJ6GEYJ472	S.M.CARB	0.1W	5%	4K7 Ω	
R1909	ERJ6GEYJ362	S.M. CAR	0.1W	5%	3K6 Ω	
R1910	ERJ6GEYJ222	S.M.CARB	0.1W	5%	2K2 Ω	
R1911	ERJ6GEY0R00	S.M.CARB	0.1W	5%	0 Ω	
R1912	ERJ6GEYJ103	S.M.CARB	0.1W	5%	10K Ω	
R1913	ERJ6GEYJ222	S.M.CARB	0.1W	5%	2K2 Ω	
R1915	ERDS1FJ390	CARBON	0.5W	5%	39 Ω	△
R2101	ERJ6GEYJ101	S.M.CARB	0.1W	5%	100 Ω	
R2102	ERJ6GEYJ101	S.M.CARB	0.1W	5%	100 Ω	
R2103	ERJ6GEY0R00	S.M.CARB	0.1W	5%	0 Ω	
R2104	ERJ6GEY0R00	S.M.CARB	0.1W	5%	0 Ω	
R2105	ERJ6GEYJ102	S.M.CARB	0.1W	5%	1K Ω	
R2106	ERJ6GEYJ101	S.M.CARB	0.1W	5%	100 Ω	
R2107	ERJ6GEYJ101	S.M.CARB	0.1W	5%	100 Ω	
R2108	ERJ6GEYJ103	S.M.CARB	0.1W	5%	10K Ω	
R2109	ERJ6GEYJ472	S.M.CARB	0.1W	5%	4K7 Ω	
R2110	ERJ6GEYJ101	S.M.CARB	0.1W	5%	100 Ω	
R2111	ERJ6GEYJ471	S.M.CARB	0.1W	5%	470 Ω	
R2112	ERJ6GEYJ472	S.M.CARB	0.1W	5%	4K7 Ω	
R2114	ERJ6GEYJ101	S.M.CARB	0.1W	5%	100 Ω	
R2117	ERJ6GEYJ222	S.M.CARB	0.1W	5%	2K2 Ω	
R2118	ERJ6GEYJ471	S.M.CARB	0.1W	5%	470 Ω	
R2120	ERJ6GEYJ471	S.M.CARB	0.1W	5%	470 Ω	
R2121	ERJ6GEYJ222	S.M.CARB	0.1W	5%	2K2 Ω	
R2122	ERJ6GEYJ471	S.M.CARB	0.1W	5%	470 Ω	
R2123	ERJ6GEYJ222	S.M.CARB	0.1W	5%	2K2 Ω	
R2124	ERJ6GEYJ101	S.M.CARB	0.1W	5%	100 Ω	
R2125	ERJ6GEYJ103	S.M.CARB	0.1W	5%	10K Ω	
R2200	ERJ6GEYJ183	S.M.CARB	0.1W	5%	18K Ω	

Cct Ref	Parts Number	Description				
R2201	ERJ6GEYJ393	S.M.CARB	0.1W	5%	39K Ω	
R2202	ERJ6GEYJ564	S.M.CARB	0.1W	5%	560K Ω	
R2203	ERJ6GEYJ103	S.M.CARB	0.1W	5%	10K Ω	
R2204	ERJ6GEYJ822	S.M.CARB	0.1W	5%	8K2 Ω	
R2205	ERJ6GEYJ562	S.M.CARB	0.1W	5%	5K6 Ω	
R2206	ERJ6GEYJ332	S.M.CARB	0.1W	5%	3K3 Ω	
R2207	ERJ6GEYJ472	S.M.CARB	0.1W	5%	4K7 Ω	
R2208	ERJ6GEYJ103	S.M.CARB	0.1W	5%	10K Ω	
R2209	ERJ6GEYJ103	S.M.CARB	0.1W	5%	10K Ω	
R2210	ERJ6GEYJ822	S.M.CARB	0.1W	5%	8K2 Ω	
R2211	ERJ6GEYJ392	S.M.CARB	0.1W	5%	3K9 Ω	
R2212	ERJ6GEYJ224	S.M.CARB	0.1W	5%	220K Ω	
R2213	ERJ6GEYJ103	S.M.CARB	0.1W	5%	10K Ω	
R2214	ERJ6GEYJ103	S.M.CARB	0.1W	5%	10K Ω	
R2215	ERJ6GEYJ822	S.M.CARB	0.1W	5%	8K2 Ω	
R2220	ERJ6GEYJ183	S.M.CARB	0.1W	5%	18K Ω	
R2221	ERJ6GEYJ393	S.M.CARB	0.1W	5%	39K Ω	
R2222	ERJ6GEYJ564	S.M.CARB	0.1W	5%	560K Ω	
R2223	ERJ6GEYJ103	S.M.CARB	0.1W	5%	10K Ω	
R2224	ERJ6GEYJ822	S.M.CARB	0.1W	5%	8K2 Ω	
R2225	ERJ6GEYJ562	S.M.CARB	0.1W	5%	5K6 Ω	
R2226	ERJ6GEYJ332	S.M.CARB	0.1W	5%	3K3 Ω	
R2227	ERJ6GEYJ472	S.M.CARB	0.1W	5%	4K7 Ω	
R2228	ERJ6GEYJ103	S.M.CARB	0.1W	5%	10K Ω	
R2229	ERJ6GEYJ103	S.M.CARB	0.1W	5%	10K Ω	
R2230	ERJ6GEYJ822	S.M.CARB	0.1W	5%	8K2 Ω	
R2231	ERJ6GEYJ392	S.M.CARB	0.1W	5%	3K9 Ω	
R2232	ERJ6GEYJ224	S.M.CARB	0.1W	5%	220K Ω	
R2233	ERJ6GEYJ103	S.M.CARB	0.1W	5%	10K Ω	
R2234	ERJ6GEYJ103	S.M.CARB	0.1W	5%	10K Ω	
R2235	ERJ6GEYJ822	S.M.CARB	0.1W	5%	8K2 Ω	
R2301	ERJ6GEYJ104	S.M.CARB	0.1W	5%	100K Ω	
R2302	ERJ6GEYJ103	S.M.CARB	0.1W	5%	10K Ω	
R2303	ERJ6GEYJ104	S.M.CARB	0.1W	5%	100K Ω	
R2304	ERJ6GEYJ471	S.M.CARB	0.1W	5%	470 Ω	
R2307	ERJ6GEYJ471	S.M.CARB	0.1W	5%	470 Ω	
R2308	ERJ6GEYJ103	S.M.CARB	0.1W	5%	10K Ω	
R2312	ERJ6GEYJ272	S.M.CARB	0.1W	5%	2K7 Ω	
R2314	ERJ6GEYJ471	S.M.CARB	0.1W	5%	470 Ω	
R2315	ERJ6GEYJ471	S.M.CARB	0.1W	5%	470 Ω	
R2316	ERJ6GEYJ222	S.M.CARB	0.1W	5%	2K2 Ω	
R2318	ERJ6GEYJ331	S.M.CARB	0.1W	5%	330 Ω	
R2319	ERJ6GEYJ222	S.M.CARB	0.1W	5%	2K2 Ω	
R2320	ERJ6GEYJ101	S.M.CARB	0.1W	5%	100 Ω	
R2321	ERJ6GEYJ101	S.M.CARB	0.1W	5%	100 Ω	
R2351	ERJ6GEYJ102	S.M.CARB	0.1W	5%	1K Ω	
R2352	ERJ6GEYJ102	S.M.CARB	0.1W	5%	1K Ω	
R2353	ERJ6GEYJ103	S.M.CARB	0.1W	5%	10K Ω	
R2354	ERJ6GEYJ103	S.M.CARB	0.1W	5%	10K Ω	
R2355	ERJ6GEYJ103	S.M.CARB	0.1W	5%	10K Ω	
R2356	ERJ6GEYJ103	S.M.CARB	0.1W	5%	10K Ω	
R2357	ERJ6GEYJ562	S.M.CARB	0.1W	5%	5K6 Ω	
R2358	ERJ6GEYJ562	S.M.CARB	0.1W	5%	5K6 Ω	
R2359	ERJ6GEYJ393	S.M.CARB	0.1W	5%	39K Ω	
R2361	ERJ6GEYJ223	S.M.CARB	0.1W	5%	22K Ω	
R2362	ERJ6GEYJ103	S.M.CARB	0.1W	5%	10K Ω	
R2363	ERJ6GEYJ103	S.M.CARB	0.1W	5%	10K Ω	
R2364	ERD25TJ101	CARBON	0.25W	5%	100 Ω	
R2365	ERJ6GEYJ102	S.M.CARB	0.1W	5%	1K Ω	
R2368	ERJ6GEYJ222	S.M.CARB	0.1W	5%	2K2 Ω	
R2369	ERJ6GEYJ222	S.M.CARB	0.1W	5%	2K2 Ω	
R2370	ERJ6GEYJ103	S.M.CARB	0.1W	5%	10K Ω	
R2371	ERJ6GEYJ103	S.M.CARB	0.1W	5%	10K Ω	
R2372	ERJ6GEYJ562	S.M.CARB	0.1W	5%	5K6 Ω	
R2373	ERJ6GEYJ562	S.M.CARB	0.1W	5%	5K6 Ω	
R2376	ERJ6GEYJ103	S.M.CARB	0.1W	5%	10K Ω	

Cct Ref	Parts Number	Description				
R2377	ERJ6GEYJ103	S.M.CARB	0.1W	5%	10K Ω	
R2401	ERJ6GEYJ102	S.M.CARB	0.1W	5%	1K Ω	
R2402	ERJ6GEYJ102	S.M.CARB	0.1W	5%	1K Ω	
R2403	ERJ6GEYJ102	S.M.CARB	0.1W	5%	1K Ω	
R2404	ERJ6GEYJ102	S.M.CARB	0.1W	5%	1K Ω	
R2405	ERJ6GEYJ102	S.M.CARB	0.1W	5%	1K Ω	
R2406	ERD25TJ102	CARBON	0.25W	5%	1K Ω	
R2408	ERJ6GEYJ473	S.M.CARB	0.1W	5%	47K Ω	
R2417	ERJ6GEYJ562	S.M.CARB	0.1W	5%	5K6 Ω	
R2421	ERJ6GEYJ562	S.M.CARB	0.1W	5%	5K6 Ω	
R2422	ERJ6GEYJ273	S.M.CARB	0.1W	5%	27K Ω	
R2423	ERJ6GEYJ184	S.M.CARB	0.1W	5%	180K Ω	
R2424	ERJ6GEYJ184	S.M.CARB	0.1W	5%	180K Ω	
R2425	ERJ6GEYJ273	S.M.CARB	0.1W	5%	27K Ω	
R2426	ERJ6GEYJ104	S.M.CARB	0.1W	5%	100K Ω	
R2427	ERJ6GEYJ104	S.M.CARB	0.1W	5%	100K Ω	
R2428	ERJ6GEYJ104	S.M.CARB	0.1W	5%	100K Ω	
R2429	ERJ6GEYJ273	S.M.CARB	0.1W	5%	27K Ω	
R2430	ERJ6GEYJ273	S.M.CARB	0.1W	5%	27K Ω	
R2431	ERJ6GEYJ104	S.M.CARB	0.1W	5%	100K Ω	
R2432	ERJ6GEYJ184	S.M.CARB	0.1W	5%	180K Ω	
R2433	ERJ6GEYJ184	S.M.CARB	0.1W	5%	180K Ω	
R2441	ERJ6GEYJ821	S.M.CARB	0.1W	5%	820 Ω	
R2442	ERJ6GEYJ332	S.M.CARB	0.1W	5%	3K3 Ω	
R2443	ERJ6GEYJ821	S.M.CARB	0.1W	5%	820 Ω	
R2444	ERJ6GEYJ821	S.M.CARB	0.1W	5%	820 Ω	
R2445	ERJ6GEYJ332	S.M.CARB	0.1W	5%	3K3 Ω	
R2446	ERJ6GEYJ332	S.M.CARB	0.1W	5%	3K3 Ω	
R2447	ERJ6GEYJ821	S.M.CARB	0.1W	5%	820 Ω	
R2448	ERJ6GEYJ332	S.M.CARB	0.1W	5%	3K3 Ω	
R2449	ERJ6GEYJ821	S.M.CARB	0.1W	5%	820 Ω	
R2450	ERJ6GEYJ821	S.M.CARB	0.1W	5%	820 Ω	
R2451	ERJ6GEYJ332	S.M.CARB	0.1W	5%	3K3 Ω	
R2452	ERJ6GEYJ332	S.M.CARB	0.1W	5%	3K3 Ω	
R2453	ERJ6GEYJ473	S.M.CARB	0.1W	5%	47K Ω	
R2454	ERJ6GEYJ473	S.M.CARB	0.1W	5%	47K Ω	
R2455	ERJ6GEYJ473	S.M.CARB	0.1W	5%	47K Ω	
R2456	ERJ6GEYJ473	S.M.CARB	0.1W	5%	47K Ω	
R2457	ERJ6GEYJ473	S.M.CARB	0.1W	5%	47K Ω	
R2458	ERJ6GEYJ473	S.M.CARB	0.1W	5%	47K Ω	
R2461	ERJ6GEYJ184	S.M.CARB	0.1W	5%	180K Ω	
R2462	ERJ6GEYJ203	S.M.CARB	0.1W	5%	20K Ω	
R2463	ERJ6GEYJ104	S.M.CARB	0.1W	5%	100K Ω	
R2464	ERJ6GEYJ184	S.M.CARB	0.1W	5%	180K Ω	
R2465	ERJ6GEYJ123	S.M.CARB	0.1W	5%	12K Ω	
R2466	ERJ6GEYJ104	S.M.CARB	0.1W	5%	100K Ω	
R2471	ERJ6GEYJ101	S.M.CARB	0.1W	5%	100 Ω	
R2472	ERJ6GEYJ101	S.M.CARB	0.1W	5%	100 Ω	
R2473	ERJ6GEYJ101	S.M.CARB	0.1W	5%	100 Ω	
R2474	ERJ6GEYJ101	S.M.CARB	0.1W	5%	100 Ω	
R2475	ERJ6GEYJ101	S.M.CARB	0.1W	5%	100 Ω	
R2476	ERJ6GEYJ101	S.M.CARB	0.1W	5%	100 Ω	
R2501	ERJ6GEYJ101	S.M.CARB	0.1W	5%	100 Ω	
R2502	ERJ6GEYJ473	S.M.CARB	0.1W	5%	47K Ω	
R2503	ERJ6GEY0R00	S.M.CARB	0.1W	5%	0 Ω	
R2504	ERJ6GEYJ222	S.M.CARB	0.1W	5%	2K2 Ω	
R2508	ERJ6GEYJ471	S.M.CARB	0.1W	5%	470 Ω	
R2509	ERJ6GEYJ471	S.M.CARB	0.1W	5%	470 Ω	
R2511	ERJ6GEYJ101	S.M.CARB	0.1W	5%	100 Ω	
R2512	ERJ6GEYJ222	S.M.CARB	0.1W	5%	2K2 Ω	
R2513	ERJ6GEYJ101	S.M.CARB	0.1W	5%	100 Ω	
R2514	ERJ6GEYJ101	S.M.CARB	0.1W	5%	100 Ω	
R2515	ERJ6GEYJ101	S.M.CARB	0.1W	5%	100 Ω	
R2516	ERJ6GEYJ101	S.M.CARB	0.1W	5%	100 Ω	
R2517	ERJ6GEYJ101	S.M.CARB	0.1W	5%	100 Ω	
R2518	ERJ6GEYJ101	S.M.CARB	0.1W	5%	100 Ω	

Cct Ref	Parts Number	Description				
R2519	ERJ6GEYJ101	S.M.CARB	0.1W	5%	100 Ω	
R2525	ERJ6GEYJ471	S.M.CARB	0.1W	5%	470 Ω	
R2526	ERJ6GEYJ222	S.M.CARB	0.1W	5%	2K2 Ω	
R2527	ERJ6GEY0R00	S.M.CARB	0.1W	5%	0 Ω	
R2528	ERJ6GEYJ103	S.M.CARB	0.1W	5%	10K Ω	
R2529	ERJ6GEY0R00	S.M.CARB	0.1W	5%	0 Ω	
R2543	ERG3FJ471	METAL	3W	5%	470 Ω	△
R2544	ERG3FJ471	METAL	3W	5%	470 Ω	△
R2545	ERD25TC0T	CARBON	0.25W	5%	0 Ω	
R2551	ERDS1TJ154	CARBON	0.5W	5%	150 Ω	
R2552	ERDS1TJ184	CARBON	0.5W	5%	180 Ω	
R2553	ERW12PKR33	WOUND	0.5W	10%	R33 Ω	△
R2554	ERD2FCVJ4R7P	CARBON	2W	5%	4R7 Ω	△
R2555	ERG2FJ101H	METAL	2W	5%	100 Ω	△
R2556	ERG2FJ101H	METAL	2W	5%	100 Ω	△
R2558	ERG5FJ473	METAL	5W	5%	47K Ω	△
R2559	ERD2FCVJ4R7P	CARBON	2W	5%	4R7 Ω	△
R2586	ERG5FJ390H	METAL	5W	5%	39 Ω	△
R2588	ERQ2CJP2R4	METAL	2W	5%	2R4 Ω	△
R2595	ERDS1TJ103	CARBON	0.5W	5%	10K Ω	
R2597	ERD25TJ820	CARBON	0.25W	5%	82 Ω	
R2598	ERD25TJ102	CARBON	0.25W	5%	1K Ω	
R2608	ERD25TJ223	CARBON	0.25W	5%	22K Ω	
R2609	ERD25TJ223	CARBON	0.25W	5%	22K Ω	
R2610	ERJ6GEYJ471	S.M.CARB	0.1W	5%	470 Ω	
R2611	ERJ6GEYJ103	S.M.CARB	0.1W	5%	10K Ω	
R2612	ERJ6GEYJ103	S.M.CARB	0.1W	5%	10K Ω	
R2613	ERJ6GEYJ272	S.M.CARB	0.1W	5%	2K7 Ω	
R2614	ERJ6GEYJ331	S.M.CARB	0.1W	5%	330 Ω	
R2615	ERJ6GEYJ222	S.M.CARB	0.1W	5%	2K2 Ω	
R2616	ERJ6GEYJ104	S.M.CARB	0.1W	5%	100K Ω	
R2617	ERJ6GEYJ103	S.M.CARB	0.1W	5%	10K Ω	
R2618	ERJ6GEYJ272	S.M.CARB	0.1W	5%	2K7 Ω	
R2619	ERJ6GEYJ331	S.M.CARB	0.1W	5%	330 Ω	
R2620	ERJ6GEYJ471	S.M.CARB	0.1W	5%	470 Ω	
R2621	ERJ6GEYJ103	S.M.CARB	0.1W	5%	10K Ω	
R2622	ERJ6GEYJ103	S.M.CARB	0.1W	5%	10K Ω	
R2623	ERJ6GEYJ272	S.M.CARB	0.1W	5%	2K7 Ω	
R2624	ERJ6GEYJ331	S.M.CARB	0.1W	5%	330 Ω	
R2625	ERDS1TJ225	CARBON	0.5W	5%	2M2 Ω	
R2630	ERJ6GEYJ223	S.M.CARB	0.1W	5%	22K Ω	
R2631	ERJ6GEY0R00	S.M.CARB	0.1W	5%	0 Ω	
R2632	ERJ6GEYJ331	S.M.CARB	0.1W	5%	330 Ω	
R2633	ERJ6GEYJ223	S.M.CARB	0.1W	5%	22K Ω	
R2634	ERX12SJW1R0E	METAL	12W	5%	1 Ω	
R2640	ERJ6GEYJ223	S.M.CARB	0.1W	5%	22K Ω	
R2641	ERJ6GEY0R00	S.M.CARB	0.1W	5%	0 Ω	
R2642	ERJ6GEYJ331	S.M.CARB	0.1W	5%	330 Ω	
R2643	ERJ6GEYJ223	S.M.CARB	0.1W	5%	22K Ω	
R2644	ERX12SJW1R0E	METAL	12W	5%	1 Ω	
R2650	ERJ6GEYJ183	S.M.CARB	0.1W	5%	18K Ω	
R2651	ERJ6GEYJ153	S.M.CARB	0.1W	5%	15K Ω	
R2652	ERJ6GEYJ271	S.M.CARB	0.1W	5%	270 Ω	
R2653	ERJ6GEYJ223	S.M.CARB	0.1W	5%	22K Ω	
R2654	ERX12SJW1R0E	METAL	12W	5%	1 Ω	
R2660	ERJ6GEYJ183	S.M.CARB	0.1W	5%	18K Ω	
R2661	ERJ6GEYJ153	S.M.CARB	0.1W	5%	15K Ω	
R2662	ERJ6GEYJ271	S.M.CARB	0.1W	5%	270 Ω	
R2663	ERJ6GEYJ223	S.M.CARB	0.1W	5%	22K Ω	
R2664	ERX12SJW1R0E	METAL	12W	5%	1 Ω	
R2670	ERJ6GEYJ222	S.M.CARB	0.1W	5%	2K2 Ω	
R2671	ERJ6GEYJ153	S.M.CARB	0.1W	5%	15K Ω	
R2672	ERJ6GEYJ391	S.M.CARB	0.1W	5%	390 Ω	
R2673	ERJ6GEYJ104	S.M.CARB	0.1W	5%	100K Ω	
R2674	ERX12SJW1R0E	METAL	12W	5%	1 Ω	
R2675	ERJ6GEYJ564	S.M.CARB	0.1W	5%	560K Ω	

Cct Ref	Parts Number	Description				
R2676	ERJ6GEYJ104	S.M.CARB	0.1W	5%	100K Ω	
R2678	ERJ6GEYJ103	S.M.CARB	0.1W	5%	10K Ω	
R3004	ERJ6GEYJ470	S.M.CARB	0.1W	5%	47 Ω	
R3005	ERJ6GEYJ104	S.M.CARB	0.1W	5%	100K Ω	
R3006	ERJ6GEYJ221	S.M.CARB	0.1W	5%	220 Ω	
R3007	ERJ6GEY0R00	S.M.CARB	0.1W	5%	0 Ω	
R3008	ERJ6GEYJ470	S.M.CARB	0.1W	5%	47 Ω	
R3009	ERJ6GEYJ470	S.M.CARB	0.1W	5%	47 Ω	
R3010	ERJ6GEYJ104	S.M.CARB	0.1W	5%	100K Ω	
R3011	ERJ6GEYJ104	S.M.CARB	0.1W	5%	100K Ω	
R3012	ERJ6GEYJ104	S.M.CARB	0.1W	5%	100K Ω	
R3013	ERJ6GEYJ101	S.M.CARB	0.1W	5%	100 Ω	
R3014	ERJ6GEYJ101	S.M.CARB	0.1W	5%	100 Ω	
R3015	ERJ6GEYJ470	S.M.CARB	0.1W	5%	47 Ω	
R3016	ERJ6GEYJ121	S.M.CARB	0.1W	5%	120 Ω	
R3017	ERJ6GEYJ390	S.M.CARB	0.1W	5%	39 Ω	
R3018	ERJ6GEYJ101	S.M.CARB	0.1W	5%	100 Ω	
R3019	ERJ6GEYJ101	S.M.CARB	0.1W	5%	100 Ω	
R3020	ERJ6GEYJ101	S.M.CARB	0.1W	5%	100 Ω	
R3021	ERJ6GEYJ681	S.M.CARB	0.1W	5%	680 Ω	
R3022	ERJ6GEYJ680	S.M.CARB	0.1W	5%	68 Ω	
R3023	ERQ14AJ390	FUSIBLE	0.25W	5%	39 Ω	△
R3024	ERJ6GEYJ683	S.M.CARB	0.1W	5%	68K Ω	
R3025	ERJ6GEYJ153	S.M.CARB	0.1W	5%	15K Ω	
R3026	ERJ6GEYJ221	S.M.CARB	0.1W	5%	220 Ω	
R3027	ERJ6GEYJ100	S.M.CARB	0.1W	5%	10 Ω	
R3028	ERJ6GEYJ681	S.M.CARB	0.1W	5%	680 Ω	
R3029	ERJ6GEYJ100	S.M.CARB	0.1W	5%	10 Ω	
R3030	ERJ6GEYJ153	S.M.CARB	0.1W	5%	15K Ω	
R3031	ERJ6GEYJ472	S.M.CARB	0.1W	5%	4K7 Ω	
R3033	ERJ6GEYJ103	S.M.CARB	0.1W	5%	10K Ω	
R3034	ERJ6GEYJ103	S.M.CARB	0.1W	5%	10K Ω	
R3035	ERJ6GEYJ103	S.M.CARB	0.1W	5%	10K Ω	
R3036	ERJ6GEYJ101	S.M.CARB	0.1W	5%	100 Ω	
R3037	ERJ6GEYJ103	S.M.CARB	0.1W	5%	10K Ω	
R3038	ERJ6GEYJ332	S.M.CARB	0.1W	5%	3K3 Ω	
R3039	ERJ6GEYJ332	S.M.CARB	0.1W	5%	3K3 Ω	
R3040	ERJ6GEYJ101	S.M.CARB	0.1W	5%	100 Ω	
R3041	ERJ6GEYJ101	S.M.CARB	0.1W	5%	100 Ω	
R3042	ERJ6GEYJ101	S.M.CARB	0.1W	5%	100 Ω	
R3043	ERJ6GEYJ471	S.M.CARB	0.1W	5%	470 Ω	
R3044	ERJ6GEYJ100	S.M.CARB	0.1W	5%	10 Ω	
R3045	ERJ6GEY0R00	S.M.CARB	0.1W	5%	0 Ω	
R3046	ERJ6GEYJ102	S.M.CARB	0.1W	5%	1K Ω	
R3047	ERJ6GEY0R00	S.M.CARB	0.1W	5%	0 Ω	
R3048	ERJ6GEYJ102	S.M.CARB	0.1W	5%	1K Ω	
R3049	ERJ6GEY0R00	S.M.CARB	0.1W	5%	0 Ω	
R3050	ERJ6GEYJ102	S.M.CARB	0.1W	5%	1K Ω	
R3051	ERJ6GEY0R00	S.M.CARB	0.1W	5%	0 Ω	
R3052	ERJ6GEYJ102	S.M.CARB	0.1W	5%	1K Ω	
R3053	ERJ6GEYJ220	S.M.CARB	0.1W	5%	22 Ω	
R3055	ERJ6GEYJ151	S.M.CARB	0.1W	5%	150 Ω	
R3056	ERJ6GEYJ151	S.M.CARB	0.1W	5%	150 Ω	
R3057	ERJ6GEYJ151	S.M.CARB	0.1W	5%	150 Ω	
R3058	ERJ6GEYJ104	S.M.CARB	0.1W	5%	100K Ω	
R3059	ERJ6GEYJ102	S.M.CARB	0.1W	5%	1K Ω	
R3060	ERJ6GEYJ471	S.M.CARB	0.1W	5%	470 Ω	
R3061	ERJ6GEYJ153	S.M.CARB	0.1W	5%	15K Ω	
R3062	ERJ6GEYJ562	S.M.CARB	0.1W	5%	5K6 Ω	
R3063	ERJ6GEYJ222	S.M.CARB	0.1W	5%	2K2 Ω	
R3064	ERJ6GEYJ272	S.M.CARB	0.1W	5%	2K7 Ω	
R3065	ERJ6GEYJ333	S.M.CARB	0.1W	5%	33K Ω	
R3066	ERJ6GEYJ471	S.M.CARB	0.1W	5%	470 Ω	
R3067	ERJ6GEYJ102	S.M.CARB	0.1W	5%	1K Ω	
R3068	ERJ6GEYJ563	S.M.CARB	0.1W	5%	56K Ω	
R3069	ERJ6GEYJ183	S.M.CARB	0.1W	5%	18K Ω	

Cct Ref	Parts Number	Description				
R3070	ERJ6GEYJ102	S.M.CARB	0.1W	5%	1K Ω	
R3071	ERJ6GEYJ621	S.M. CAR	0.1W	5%	620 Ω	
R3072	ERJ6GEYJ103	S.M.CARB	0.1W	5%	10K Ω	
R3073	ERJ6GEYJ393	S.M.CARB	0.1W	5%	39K Ω	
R3074	ERJ6GEYJ473	S.M.CARB	0.1W	5%	47K Ω	
R3075	ERJ6GEYJ472	S.M.CARB	0.1W	5%	4K7 Ω	
R3076	ERJ6GEYJ331	S.M.CARB	0.1W	5%	330 Ω	
R3077	ERJ6GEYJ101	S.M.CARB	0.1W	5%	100 Ω	
R3078	ERJ6GEY0R00	S.M.CARB	0.1W	5%	0 Ω	
R3079	ERJ6GEYJ101	S.M.CARB	0.1W	5%	100 Ω	
R3080	ERJ6GEYJ101	S.M.CARB	0.1W	5%	100 Ω	
R3081	ERJ6GEYJ101	S.M.CARB	0.1W	5%	100 Ω	
R3082	ERJ6GEYJ101	S.M.CARB	0.1W	5%	100 Ω	
R3087	ERJ6GEYJ750	S.M.CARB	0.1W	5%	75 Ω	
R3113	ERJ6GEYJ101	S.M.CARB	0.1W	5%	100 Ω	
R3114	ERJ6GEYJ101	S.M.CARB	0.1W	5%	100 Ω	
R3125	ERJ6GEYJ681	S.M.CARB	0.1W	5%	680 Ω	
R3126	ERJ6GEYJ681	S.M.CARB	0.1W	5%	680 Ω	
R3281	ERD25TJ750	CARBON	0.25W	5%	75 Ω	
R3282	ERD25TJ750	CARBON	0.25W	5%	75 Ω	
R3284	ERD25TJ102	CARBON	0.25W	5%	1K Ω	
R3285	ERD25TJ102	CARBON	0.25W	5%	1K Ω	
R3351	ERJ6GEYJ220	S.M.CARB	0.1W	5%	22 Ω	
R3352	ERJ6GEYJ472	S.M.CARB	0.1W	5%	4K7 Ω	
R3353	ERJ6GEYJ474	S.M.CARB	0.1W	5%	470K Ω	
R3354	ERJ6GEYJ102	S.M.CARB	0.1W	5%	1K Ω	
R3355	ERJ6GEYJ391	S.M.CARB	0.1W	5%	390 Ω	
R3356	ERJ6GEYJ682	S.M.CARB	0.1W	5%	6K8 Ω	
R3357	ERJ6GEYJ682	S.M.CARB	0.1W	5%	6K8 Ω	
R3358	ERJ6GEYJ682	S.M.CARB	0.1W	5%	6K8 Ω	
R3360	ERDS1TJ471	CARBON	0.5W	5%	470 Ω	
R3361	ERO50PKF1133	METAL	0.5W	5%	110K Ω	△
R3401	ERJ6GEYJ101	S.M.CARB	0.1W	5%	100 Ω	
R3402	ERJ6GEYJ101	S.M.CARB	0.1W	5%	100 Ω	
R3403	ERJ6GEYJ333	S.M.CARB	0.1W	5%	33K Ω	
R3404	ERJ6GEYJ333	S.M.CARB	0.1W	5%	33K Ω	
R3405	ERJ6GEYJ102	S.M.CARB	0.1W	5%	1K Ω	
R3406	ERJ6GEYJ102	S.M.CARB	0.1W	5%	1K Ω	
R3407	ERJ6GEYJ153	S.M.CARB	0.1W	5%	15K Ω	
R3408	ERJ6GEYJ102	S.M.CARB	0.1W	5%	1K Ω	
R3409	ERJ6GEYJ102	S.M.CARB	0.1W	5%	1K Ω	
R3410	ERJ6GEYJ104	S.M.CARB	0.1W	5%	100K Ω	
R3412	ERJ6GEYJ102	S.M.CARB	0.1W	5%	1K Ω	
R3413	ERJ6GEYJ102	S.M.CARB	0.1W	5%	1K Ω	
R3414	ERJ6GEYJ750	S.M.CARB	0.1W	5%	75 Ω	
R3415	ERJ6GEYJ104	S.M.CARB	0.1W	5%	100K Ω	
R3416	ERJ6GEYJ333	S.M.CARB	0.1W	5%	33K Ω	
R3417	ERJ6GEYJ104	S.M.CARB	0.1W	5%	100K Ω	
R3418	ERJ6GEYJ104	S.M.CARB	0.1W	5%	100K Ω	
R3419	ERJ6GEYJ333	S.M.CARB	0.1W	5%	33K Ω	
R3420	ERJ6GEYJ750	S.M.CARB	0.1W	5%	75 Ω	
R3421	ERJ6GEYJ750	S.M.CARB	0.1W	5%	75 Ω	
R3422	ERJ6GEYJ153	S.M.CARB	0.1W	5%	15K Ω	
R3423	ERJ6GEYJ470	S.M.CARB	0.1W	5%	47 Ω	
R3424	ERJ6GEYJ101	S.M.CARB	0.1W	5%	100 Ω	
R3425	ERJ6GEYJ221	S.M.CARB	0.1W	5%	220 Ω	
R3426	ERJ6GEYJ680	S.M.CARB	0.1W	5%	68 Ω	
R3427	ERJ6GEYJ102	S.M.CARB	0.1W	5%	1K Ω	
R3428	ERJ6GEYJ680	S.M.CARB	0.1W	5%	68 Ω	
R3429	ERJ6GEYJ100	S.M.CARB	0.1W	5%	10 Ω	
R3430	ERJ6GEYJ103	S.M.CARB	0.1W	5%	10K Ω	
R3431	ERJ6GEYJ101	S.M.CARB	0.1W	5%	100 Ω	
R3432	ERJ6GEYJ221	S.M.CARB	0.1W	5%	220 Ω	
R3433	ERJ6GEYJ332	S.M.CARB	0.1W	5%	3K3 Ω	
R3434	ERJ6GEYJ333	S.M.CARB	0.1W	5%	33K Ω	
R3435	ERJ6GEYJ680	S.M.CARB	0.1W	5%	68 Ω	

Cct Ref	Parts Number	Description			
R3436	ERJ6GEYJ102	S.M.CARB	0.1W	5%	1K Ω
R3437	ERJ6GEYJ102	S.M.CARB	0.1W	5%	1K Ω
R3438	ERJ6GEYJ101	S.M.CARB	0.1W	5%	100 Ω
R3439	ERJ6GEYJ333	S.M.CARB	0.1W	5%	33K Ω
R3440	ERJ6GEYJ102	S.M.CARB	0.1W	5%	1K Ω
R3441	ERJ6GEYJ153	S.M.CARB	0.1W	5%	15K Ω
R3443	ERJ6GEYJ750	S.M.CARB	0.1W	5%	75 Ω
R3444	ERJ6GEYJ470	S.M.CARB	0.1W	5%	47 Ω
R3445	ERJ6GEYJ750	S.M.CARB	0.1W	5%	75 Ω
R3446	ERJ6GEYJ102	S.M.CARB	0.1W	5%	1K Ω
R3447	ERJ6GEYJ102	S.M.CARB	0.1W	5%	1K Ω
R3452	ERJ6GEYJ101	S.M.CARB	0.1W	5%	100 Ω
R3453	ERJ6GEYJ101	S.M.CARB	0.1W	5%	100 Ω
R3454	ERJ6GEYJ101	S.M.CARB	0.1W	5%	100 Ω
R3455	ERJ6GEYJ101	S.M.CARB	0.1W	5%	100 Ω
R3801	ERJ6GEYJ101	S.M.CARB	0.1W	5%	100 Ω
R3802	ERJ6GEYJ221	S.M.CARB	0.1W	5%	220 Ω
R3803	ERG3FJ100	METAL	3W	5%	10 Ω <sup>△</sup>
R3918	ERJ6GEYJ272	S.M.CARB	0.1W	5%	2K7 Ω
R3919	ERJ6GEYJ273	S.M.CARB	0.1W	5%	27K Ω
R3920	ERJ6GEYJ103	S.M.CARB	0.1W	5%	10K Ω
R3921	ERJ6GEYJ153	S.M.CARB	0.1W	5%	15K Ω
R3922	EVMEASA00B53	CONTROL			5K Ω
R3923	ERJ6GEYJ562	S.M.CARB	0.1W	5%	5K6 Ω
R3925	ERO25CKF1272	METAL	0.25W	5%	2K7 Ω <sup>△</sup>
R3926	ERO25CKF3242	METAL	0.25W	5%	2K4 Ω <sup>△</sup>
R3927	ERD25TJ822	CARBON	0.25W	5%	8K2 Ω
R3928	ERDS1FJ103	CARBON	0.5W	5%	10K Ω <sup>△</sup>
R3929	ERJ6GEYJ472	S.M.CARB	0.1W	5%	4K7 Ω
R3930	ERDS1FJ103	CARBON	0.5W	5%	10K Ω <sup>△</sup>
R3931	ERJ6GEYJ561	S.M.CARB	0.1W	5%	560 Ω
R3932	ERJ6GEYJ103	S.M.CARB	0.1W	5%	10K Ω
R3933	ERJ6GEYJ103	S.M.CARB	0.1W	5%	10K Ω
R3934	ERJ6GEYJ564	S.M.CARB	0.1W	5%	560K Ω
R3935	ERDS1FJ561	CARBON	0.5W	5%	56 Ω <sup>△</sup>
R3936	ERJ6GEYJ820	S.M.CARB	0.1W	5%	82 Ω
R3938	EVMEASA00B53	CONTROL			5K Ω
R3939	ERJ6GEYJ472	S.M.CARB	0.1W	5%	4K7 Ω
R3941	ERJ6GEYJ101	S.M.CARB	0.1W	5%	100 Ω
R3942	ERD25TJ123	CARBON	0.25W	5%	12K Ω
R3943	ERDS1TJ104	CARBON	0.5W	5%	100K Ω
R3944	ERJ6GEYJ125	S.M. CAR	0.1W	5%	1M2 Ω
R3945	ERJ6GEYJ125	S.M. CAR	0.1W	5%	1M2 Ω
R3946	ERJ6GEYJ104	S.M.CARB	0.1W	5%	100K Ω
R3947	ERG2FJ123H	METAL	2W	5%	12K Ω <sup>△</sup>
R3949	ERDS1FJ332	CARBON	0.5W	5%	3K3 Ω <sup>△</sup>
R3950	ERG3FJ471	METAL	3W	5%	470 Ω <sup>△</sup>
R3951	ERD25TJ334	CARBON	0.25W	5%	330K Ω
R3952	ERJ6GEYJ101	S.M.CARB	0.1W	5%	100 Ω
R3953	ERG3FJ471	METAL	3W	5%	470 Ω <sup>△</sup>
R3954	ERD25TJ473	CARBON	0.25W	5%	47K Ω
R3955	ERJ6GEYJ123	S.M.CARB	0.1W	5%	12K Ω
R3956	ERD25TJ104	CARBON	0.25W	5%	100K Ω
R3957	ERD25TJ104	CARBON	0.25W	5%	100K Ω
R3958	ERD25TJ104	CARBON	0.25W	5%	100K Ω
R3959	ERD25TJ104	CARBON	0.25W	5%	100K Ω
R3960	ERJ6GEYJ622	S.M.CARB	0.1W	5%	6K2 Ω
R3961	ERJ6GEYJ272	S.M.CARB	0.1W	5%	2K7 Ω
R3962	ERD25TJ563	CARBON	0.25W	5%	56K Ω
R3963	ERJ6GEYJ563	S.M.CARB	0.1W	5%	56K Ω
R3972	ERG3FJ102H	METAL	3W	5%	1K Ω <sup>△</sup>
R3973	ERJ6GEYJ102	S.M.CARB	0.1W	5%	1K Ω
R3974	ERJ6GEYJ102	S.M.CARB	0.1W	5%	1K Ω
R3975	ERJ6GEYJ102	S.M.CARB	0.1W	5%	1K Ω
R3976	ERJ6GEYJ102	S.M.CARB	0.1W	5%	1K Ω
R3978	ERJ6GEY0R00	S.M.CARB	0.1W	5%	0 Ω

Cct Ref	Parts Number	Description			
R3981	ERQ14AJ220	FUSIBLE	0.25W	5%	22 Ω <sup>△</sup>
R3982	ERJ6GEYJ333	S.M.CARB	0.1W	5%	33K Ω
R3983	ERJ6GEYJ823	S.M.CARB	0.1W	5%	82K Ω
R3984	ERJ6GEYJ123	S.M.CARB	0.1W	5%	12K Ω
R3985	ERJ6GEYJ102	S.M.CARB	0.1W	5%	1K Ω
R3986	ERJ6GEYJ103	S.M.CARB	0.1W	5%	10K Ω
R3987	ERJ6GEYJ332	S.M.CARB	0.1W	5%	3K3 Ω
R3988	ERJ6GEYJ684	S.M.CARB	0.1W	5%	680K Ω
R3989	ERJ6GEYJ221	S.M.CARB	0.1W	5%	220 Ω
R3990	ERJ6GEYJ472	S.M.CARB	0.1W	5%	4K7 Ω
R3991	ERJ6GEYJ103	S.M.CARB	0.1W	5%	10K Ω
R3992	ERJ6GEYJ103	S.M.CARB	0.1W	5%	10K Ω
R3993	ERJ6GEYJ103	S.M.CARB	0.1W	5%	10K Ω
R3994	ERJ6GEYJ103	S.M.CARB	0.1W	5%	10K Ω
S2401	TSE8E001	RELAY			Ω
<b>CAPACITORS</b>					
C002	ECA1HMR33GB	ELECT	50V		0.33μF
C003	ECUV1H104ZFX	S.M. CAP	50V		100nF
C004	ECUV1H104ZFX	S.M. CAP	50V		100nF
C005	ECA1CM221GB	ELECT	16V		220μF
C006	ECUV1H104ZFX	S.M. CAP	50V		100nF
C007	ECUV1H104ZFX	S.M. CAP	50V		100nF
C008	ECUV1H561JCX	S.M. CAP	50V		560pF
C009	ECA1CM221GB	ELECT	16V		220μF
C010	ECA1HM4R7GB	ELECT	50V		4.7μF
C011	ECUV1H100DCX	S.M. CAP	50V		10pF
C012	ECUV1H100DCX	S.M. CAP	50V		10pF
C013	ECA1CM470GB	ELECT	16V		47μF
C014	ECUV1H104ZFX	S.M. CAP	50V		100nF
C015	ECUV1H104ZFX	S.M. CAP	50V		100nF
C017	ECUV1H100DCX	S.M. CAP	50V		10pF
C018	ECJ2VF1H104Z	ELECT	350V		100nF
C019	ECJ2VF1H104Z	ELECT	350V		100nF
C103	ECUV1H104ZFX	S.M. CAP	50V		100nF
C104	ECJ2VF1H103Z	ELECT	350V		10nF
C107	ECUV1H104ZFX	S.M. CAP	50V		100nF
C108	ECUV1H104ZFX	S.M. CAP	50V		100nF
C109	ECUV1C184KBX	S.M. CAP	16V		180nF
C110	ECUV1H104ZFX	S.M. CAP	50V		100nF
C111	ECUV1H104ZFX	S.M. CAP	50V		100nF
C251	ECA1HM101GB	ELECT	50V		100μF
C252	ECUV1H103KBX	S.M. CAP	50V		10nF
C253	ECA1HM4R7GB	ELECT	50V		4.7μF
C254	ECQM1H684J	FILM	50V		680nF
C255	ECA1EHG101B	ELECT	50V		100nF
C256	ECUV1H103KBX	S.M. CAP	50V		10nF
C257	ECA1HM4R7GB	ELECT	50V		4.7μF
C258	ECA1HM101GB	ELECT	50V		100μF
C259	ECQM1H684J	FILM	50V		680nF
C260	ECA1VM102GB	ELECT	35V		1nF
C261	ECA1VM102GB	ELECT	35V		1nF
C263	ECA1HM010GB	ELECT	50V		1μF
C264	ECA1HM222E	ELECT	50V		2.2nF
C266	ECA1HM010GB	ELECT	50V		1μF
C267	ECQM1H224J	FILM	50V		220nF
C268	ECQM1H224J	FILM	50V		220nF
C269	ECA1HM470GB	ELECT	50V		47μF
C270	ECQM1H224J	FILM	50V		220nF
C271	ECQM1H224J	FILM	50V		220nF
C352	ECUV1H224ZFX	S.M. CAP	50V		220nF
C353	ECUV1H104KBX	S.M. CAP	50V		100nF
C354	ECQM2104KZ	FILM	250V		100nF
C355	ECKC2H102J	CERAMIC	500V		1nF <sup>△</sup>
C362	ECUV1H224ZFX	S.M. CAP	50V		220nF
C363	ECUV1H104KBX	S.M. CAP	50V		100nF
C364	ECQM2104KZ	FILM	250V		100nF

Cct Ref	Parts Number	Description			
C365	ECKC2H102J	CERAMIC	500V	1nF	△
C372	ECUV1H224ZFX	S.M. CAP	50V	220nF	
C373	ECUV1H104KBX	S.M. CAP	50V	100nF	
C374	ECQM2104KZ	FILM	250V	100nF	
C375	ECKC2H102J	CERAMIC	500V	1nF	△
C381	ECA1HM101GB	ELECT	50V	100μF	
C382	ECA1CM471GB	ELECT	16V	470μF	
C383	ECUV1H103KBX	S.M. CAP	50V	10nF	
C384	ECQM2104KZ	FILM	250V	100nF	
C385	ECA2EM220B	ELECT	250V	22μF	
C386	ECKC3D392J	CERAMIC	2KV	3900pF	△
C388	ECUV1H331KBX	S.M. CAP	50V	330pF	
C389	ECUV1H331KBX	S.M. CAP	50V	330pF	
C390	ECUV1H180JCX	S.M. CAP	50V	18pF	
C391	ECUV1H180JCX	S.M. CAP	50V	18pF	
C392	ECUV1H180JCX	S.M. CAP	50V	18pF	
C395	ECQM1H104J	FILM	50V	100nF	
C396	ECJ2VF1H104Z	ELECT	350V	100nF	
C397	ECKC3D222JB	CERAMIC	2KV	2200pF	△
C400	ECA1VM102GB	ELECT	35V	1nF	
C402	ECA1HM010GB	ELECT	50V	1μF	
C404	ECEA1HU471	ELECT	50V	470μF	
C407	ECQB1224KFW	FILM	100V	220nF	
C411	ECUV1H102KBX	S.M. CAP	50V	1nF	
C501	ECQM1H224J	FILM	50V	220nF	
C502	ECQM2104KZ	FILM	250V	100nF	
C503	ECKC2H102J	CERAMIC	500V	1nF	△
C504	ECQB1H223K	FILM	50V	22nF	
C505	ECA1EM332E	ELECT	25V	3300μF	
C506	ECKC2H102J	CERAMIC	500V	1nF	△
C507	ECA1EM332E	ELECT	25V	3300μF	
C552	ECWH20102JVY	FILM	200V	1μF	
C553	ECQP1223JZW	FILM	100V	22nF	
C554	ECQB1H152K	FILM	50V	1.5nF	
C555	ECWH20562JVB	FILM	200V	5.6nF	
C556	ECEA2CNR47SB	ELECT	160V	0.47μF	
C557	ECKC2H331J	CERAMIC	500V	330pF	△
C558	ECA2EM330B	ELECT	250V	33μF	
C563	ECWF2564JBB	FILM	200V	560nF	△
C565	ECQP1223JZW	FILM	100V	22nF	
C566	ECKC2H222J	CERAMIC	500V	2200pF	△
C572	ECWH20562JVB	FILM	200V	5.6nF	
C573	ECQF4103JZH	FILM	400V	10nF	
C574	ECWF4824JBB	FILM	400V	820nF	
C575	ECWF4684JBB	FILM	400V	680nF	
C581	ECQF4123JZH	FILM	400V	12nF	△
C584	ECKC3D471JB	CERAMIC	2KV	470pF	△
C602	ECUV1H104ZFX	S.M. CAP	50V	100nF	
C603	ECUV1H104ZFX	S.M. CAP	50V	100nF	
C604	ECUV1H470JCX	S.M. CAP	50V	47pF	
C605	ECA1CM221GB	ELECT	16V	220μF	
C606	ECA1AM332E	ELECT	10V	3300μF	
C607	ECUV1H104ZFX	S.M. CAP	50V	100nF	
C608	ECUV1H104ZFX	S.M. CAP	50V	100nF	
C609	ECA1HM3R3GB	ELECT	50V	3.3μF	
C610	ECUV1H104ZFX	S.M. CAP	50V	100nF	
C611	ECUV1H104ZFX	S.M. CAP	50V	100nF	
C612	ECUV1H104ZFX	S.M. CAP	50V	100nF	
C613	ECUV1H104ZFX	S.M. CAP	50V	100nF	
C614	ECUV1H104ZFX	S.M. CAP	50V	100nF	
C615	ECJ2VB1C104K	ELECT	350V	100nF	
C616	ECQM1H104J	FILM	50V	100nF	
C617	ECUV1H104ZFX	S.M. CAP	50V	100nF	
C618	ECUV1H104ZFX	S.M. CAP	50V	100nF	
C620	ECUV1H100DCX	S.M. CAP	50V	10pF	
C622	ECUV1H470JCX	S.M. CAP	50V	47pF	

Cct Ref	Parts Number	Description			
C623	ECUV1H470JCX	S.M. CAP	50V	47pF	
C624	ECUV1H820JCX	S.M. CAP	50V	82pF	
C625	ECUV1H470JCX	S.M. CAP	50V	47pF	
C626	ECUV1H470JCX	S.M. CAP	50V	47pF	
C627	ECUV1H470JCX	S.M. CAP	50V	47pF	
C628	ECUV1H470JCX	S.M. CAP	50V	47pF	
C632	ECUV1H104ZFX	S.M. CAP	50V	100nF	
C633	ECUV1H104ZFX	S.M. CAP	50V	100nF	
C634	ECUV1H222KBX	S.M. CAP	50V	2.2nF	
C635	ECA1EM101GB	ELECT	25V	100μF	
C636	ECUV1H103ZFX	S.M. CAP	50V	10nF	
C637	ECUV1H470JCX	S.M. CAP	50V	47pF	
C638	ECUV1H270JCX	S.M. CAP	50V	27pF	
C639	ECUV1H104ZFX	S.M. CAP	50V	100nF	
C641	ECUV1H101JCX	S.M. CAP	50V	100pF	
C642	ECUV1H561JCX	S.M. CAP	50V	560pF	
C643	ECUV1H102KBX	S.M. CAP	50V	1nF	
C644	ECQM1H104J	FILM	50V	100nF	
C645	ECQM1H104J	FILM	50V	100nF	
C646	ECUV1H103KBX	S.M. CAP	50V	10nF	
C651	ECUV1C224KBX	S.M. CAP	16V	220nF	
C701	ECQV1H105JZ	FILM	50V	1μF	
C702	ECKC2H102J	CERAMIC	500V	1nF	△
C807	ECQB1H473K	FILM	50V	47nF	
C808	ECQM1H334J	FILM	50V	330nF	
C811	ECQM1H104J	FILM	50V	100nF	
C812	ECQB1H562K	FILM	50V	5.6nF	
C813	ECKC2H472J	CERAMIC	500V	4.7nF	△
C814	ECKC2H472J	CERAMIC	500V	4.7nF	△
C815	ECA1CM331B	ELECT	16V	330μF	
C816	ECQB1H122J	FILM	50V	1.2nF	
C817	ECKC2H472J	CERAMIC	500V	4.7nF	△
C818	ECKC2H472J	CERAMIC	500V	4.7nF	△
C819	ECOS2WB221DB	ELECT	16V	220μF	
C820	ECOS2WB221DB	ELECT	16V	220μF	
C821	ECQB1H222J	FILM	50V	2.2nF	
C822	ECKC3D471JB	CERAMIC	2KV	470pF	△
C823	EEUFA1V221B	CERAMIC	35V	220μF	
C824	ECQB1H151JM3	FILM	50V	150pF	
C826	ECQB1H473K	FILM	50V	47nF	
C827	ECKCNS332J	CERAMIC	1.2KV	3.3nF	△
C830	ECQE6105JFW	FILM	600V	1μF	△
C831	ECKC3D471JB	CERAMIC	2KV	470pF	△
C833	ECQB1H682K	FILM	50V	6.8nF	
C835	ECQB1H332K	FILM	50V	3.3nF	
C840	ECQU2A224MN	FILM	250V	220nF	
C841	ECQE2A474MWB	FILM	250V	470nF	
C845	ECQE6104K	FILM	600V	100nF	△
C847	ECEA1EN101UB	ELECT	25V	100μF	
C848	ECKC2H331J	CERAMIC	500V	330pF	△
C849	ECKC2H391J	CERAMIC	500V	390pF	△
C852	ECKC3D222JB	CERAMIC	2KV	2200pF	△
C853	ECEA1CU332	ELECT	16V	3300μF	
C854	ECA1EM221GB	ELECT	25V	220pF	
C855	ECA1HHG102E	ELECT	50V	1nF	
C856	ECA1EM222GB	ELECT	25V	2200μF	
C857	ECA1EM471GB	ELECT	25V	470μF	
C858	43504A2277M0	ELECT	400V	270μF	
C859	ECKC2H471J	CERAMIC	500V	470pF	△
C861	ECOS2EA221AB	ELECT	250V	220μF	
C863	ECA1EM332E	ELECT	25V	3300μF	
C864	ECA0JM102GB	ELECT	6.3V	1000μF	
C866	ECA1HM101GB	ELECT	50V	100μF	
C867	ECA1CM222E	ELECT	16V	2.2nF	
C868	ECA1CM100GB	ELECT	16V	10μF	
C869	ECA1HM101GB	ELECT	50V	100μF	

Cct Ref	Parts Number	Description		
C871	ECA0JM102GB	ELECT	6.3V	1000µF
C872	ECA1CM222E	ELECT	16V	2.2nF
C901	ECUV1H030CCX	S.M. CAP	50V	30pF
C902	ECA1VM101GB	ELECT	35V	100µF
C904	ECJ2VF1H103Z	ELECT	350V	10nF
C906	ECUV1H681KBX	S.M. CAP	50V	680pF
C909	ECKC2H472J	CERAMIC	500V	4.7nF
C910	ECKC2H472J	CERAMIC	500V	4.7nF
C912	ECA2EM220B	ELECT	250V	22µF
C913	ECA1HM101GB	ELECT	50V	100µF
C914	ECA1HM101GB	ELECT	50V	100µF
C916	ECA2EM220B	ELECT	250V	22µF
C917	ECA1HM100GB	ELECT	50V	10µF
C918	ECJ2VF1H103Z	ELECT	350V	10nF
C920	ECUV1H330JCX	S.M. CAP	50V	33pF
C923	ECUV1H151JCX	S.M. CAP	50V	150pF
C1011	ECKC1H101J	CERAMIC	50V	100pF
C1012	ECA1CM470GB	ELECT	16V	47µF
C1013	ECKC1H103JB	CERAMIC	50V	10nF
C1101	ECUV1H104ZFX	S.M. CAP	50V	100nF
C1102	ECUV1H101JCX	S.M. CAP	50V	100pF
C1103	ECUV1H220JCX	S.M. CAP	50V	22pF
C1104	ECUV1H220JCX	S.M. CAP	50V	22pF
C1107	ECUV1H104ZFX	S.M. CAP	50V	100nF
C1108	ECUV1C104KBX	S.M. CAP	16V	100nF
C1109	ECUV1C104KBX	S.M. CAP	16V	100nF
C1113	ECUV1C104KBX	S.M. CAP	16V	100nF
C1114	ECA1HM101GB	ELECT	50V	100µF
C1116	ECUV1H560JCX	S.M. CAP	50V	56pF
C1117	ECUV1H221JCX	S.M. CAP	50V	220pF
C1118	ECJ3VB1C474K	ELECT	3.5KV	470nF
C1120	ECUV1H104ZFX	S.M. CAP	50V	100nF
C1121	ECUV1H472KBX	S.M. CAP	50V	4.7nF
C1122	ECA1HM010GB	ELECT	50V	1µF
C1123	ECUV1H104ZFX	S.M. CAP	50V	100nF
C1124	ECUV1H101JCX	S.M. CAP	50V	100pF
C1125	ECUV1H104ZFX	S.M. CAP	50V	100nF
C1126	ECUV1H104ZFX	S.M. CAP	50V	100nF
C1127	ECA1HM101GB	ELECT	50V	100µF
C1128	ECUV1H104ZFX	S.M. CAP	50V	100nF
C1129	ECA1HM101GB	ELECT	50V	100µF
C1130	ECUV1H103KBX	S.M. CAP	50V	10nF
C1131	ECUV1H221JCX	S.M. CAP	50V	220pF
C1138	ECUV1H224ZFX	S.M. CAP	50V	220nF
C1145	ECJ2VB1H333K	ELECT	350V	33nF
C1147	ECA1CM331B	ELECT	16V	330µF
C1148	ECUV1C224KBX	S.M. CAP	16V	220nF
C1501	ECUV1H330JCX	S.M. CAP	50V	33pF
C1502	ECUV1H471JCX	S.M. CAP	50V	470pF
C1503	ECUV1H390JCX	S.M. CAP	50V	39pF
C1504	ECUV1H680JCX	S.M. CAP	50V	68pF
C1505	ECUV1H820JCX	S.M. CAP	50V	82pF
C1506	ECUV1H331JCX	S.M. CAP	50V	330pF
C1507	ECUV1H102KBX	S.M. CAP	50V	1nF
C1508	ECEA1HN010UB	ELECT	50V	1µF
C1509	ECUV1H104ZFX	S.M. CAP	50V	100nF
C1510	ECA1HM101GB	ELECT	50V	100µF
C1511	ECUV1H104ZFX	S.M. CAP	50V	100nF
C1512	ECUV1H030CCX	S.M. CAP	50V	30pF
C1513	ECA1HM100GB	ELECT	50V	10µF
C1514	ECUV1H104ZFX	S.M. CAP	50V	100nF
C1515	ECUV1H104ZFX	S.M. CAP	50V	100nF
C1516	ECUV1H030CCX	S.M. CAP	50V	30pF
C1517	ECUV1H473ZFX	S.M. CAP	50V	47nF
C1518	ECUV1H104ZFX	S.M. CAP	50V	100nF
C1519	ECA1HM101GB	ELECT	50V	100µF

Cct Ref	Parts Number	Description		
C1521	ECA1HM101GB	ELECT	50V	100µF
C1522	ECUV1H104ZFX	S.M. CAP	50V	100nF
C1523	ECUV1H104ZFX	S.M. CAP	50V	100nF
C1524	ECA1VM470B	ELECT	35V	47µF
C1525	ECUV1H104ZFX	S.M. CAP	50V	100nF
C1527	ECUV1H104ZFX	S.M. CAP	50V	100nF
C1528	ECUV1H104ZFX	S.M. CAP	50V	100nF
C1529	ECUV1H104ZFX	S.M. CAP	50V	100nF
C1530	ECUV1H104ZFX	S.M. CAP	50V	100nF
C1532	ECUV1H104ZFX	S.M. CAP	50V	100nF
C1533	ECUV1H104ZFX	S.M. CAP	50V	100nF
C1534	ECUV1H104ZFX	S.M. CAP	50V	100nF
C1535	ECUV1H104ZFX	S.M. CAP	50V	100nF
C1536	ECUV1H104ZFX	S.M. CAP	50V	100nF
C1537	ECUV1H104ZFX	S.M. CAP	50V	100nF
C1538	EEUNA1E220B	CERAMIC	25V	22µF
C1539	ECUV1H104ZFX	S.M. CAP	50V	100nF
C1540	ECUV1H104ZFX	S.M. CAP	50V	100nF
C1541	ECUV1H104ZFX	S.M. CAP	50V	100nF
C1542	ECA1CM471GB	ELECT	16V	470µF
C1543	ECUV1H104ZFX	S.M. CAP	50V	100nF
C1544	EEUNA1E220B	CERAMIC	25V	22µF
C1545	ECUV1H104ZFX	S.M. CAP	50V	100nF
C1546	ECA1HM101GB	ELECT	50V	100µF
C1547	ECUV1H104ZFX	S.M. CAP	50V	100nF
C1548	ECUV1H104ZFX	S.M. CAP	50V	100nF
C1549	ECUV1H104ZFX	S.M. CAP	50V	100nF
C1550	ECUV1H104ZFX	S.M. CAP	50V	100nF
C1551	EEUNA1E220B	CERAMIC	25V	22µF
C1552	ECA1HM101GB	ELECT	50V	100µF
C1553	ECUV1H104ZFX	S.M. CAP	50V	100nF
C1554	ECUV1H104ZFX	S.M. CAP	50V	100nF
C1555	ECUV1H104ZFX	S.M. CAP	50V	100nF
C1556	ECA1HM101GB	ELECT	50V	100µF
C1557	ECUV1H104ZFX	S.M. CAP	50V	100nF
C1558	ECUV1H104ZFX	S.M. CAP	50V	100nF
C1559	ECUV1H104ZFX	S.M. CAP	50V	100nF
C1560	ECUV1H104ZFX	S.M. CAP	50V	100nF
C1561	ECUV1H104ZFX	S.M. CAP	50V	100nF
C1562	ECUV1H104ZFX	S.M. CAP	50V	100nF
C1563	ECA1HM101GB	ELECT	50V	100µF
C1564	ECUV1H104ZFX	S.M. CAP	50V	100nF
C1565	ECUV1H270JCX	S.M. CAP	50V	27pF
C1567	ECA1HM101GB	ELECT	50V	100µF
C1568	ECUV1H104ZFX	S.M. CAP	50V	100nF
C1569	ECUV1H104ZFX	S.M. CAP	50V	100nF
C1570	ECUV1H104ZFX	S.M. CAP	50V	100nF
C1571	ECA1CM471GB	ELECT	16V	470µF
C1572	ECUV1H104ZFX	S.M. CAP	50V	100nF
C1573	ECUV1H104ZFX	S.M. CAP	50V	100nF
C1574	ECUV1H104ZFX	S.M. CAP	50V	100nF
C1575	ECUV1H104ZFX	S.M. CAP	50V	100nF
C1576	ECUV1H104ZFX	S.M. CAP	50V	100nF
C1577	ECUV1H104ZFX	S.M. CAP	50V	100nF
C1578	ECUV1H104ZFX	S.M. CAP	50V	100nF
C1579	ECUV1H104ZFX	S.M. CAP	50V	100nF
C1580	ECUV1H104ZFX	S.M. CAP	50V	100nF
C1581	ECUV1H104ZFX	S.M. CAP	50V	100nF
C1582	ECUV1H104ZFX	S.M. CAP	50V	100nF
C1583	ECUV1H104ZFX	S.M. CAP	50V	100nF
C1584	ECUV1H104ZFX	S.M. CAP	50V	100nF
C1585	ECUV1H104ZFX	S.M. CAP	50V	100nF
C1586	ECUV1H104ZFX	S.M. CAP	50V	100nF
C1587	ECUV1H104ZFX	S.M. CAP	50V	100nF
C1588	ECUV1H104ZFX	S.M. CAP	50V	100nF
C1589	ECUV1H104ZFX	S.M. CAP	50V	100nF

Cct Ref	Parts Number	Description		
C1590	ECUV1H104ZFX	S.M. CAP	50V	100nF
C1591	ECUV1H104ZFX	S.M. CAP	50V	100nF
C1592	ECA1CM221GB	ELECT	16V	220µF
C1593	ECA1CM221GB	ELECT	16V	220µF
C1594	ECUV1H104ZFX	S.M. CAP	50V	100nF
C1595	ECUV1H104ZFX	S.M. CAP	50V	100nF
C1596	ECUV1H104ZFX	S.M. CAP	50V	100nF
C1597	ECUV1H104ZFX	S.M. CAP	50V	100nF
C1598	ECUV1H104ZFX	S.M. CAP	50V	100nF
C1599	ECUV1H104ZFX	S.M. CAP	50V	100nF
C1600	ECUV1H104ZFX	S.M. CAP	50V	100nF
C1601	ECUV1H104ZFX	S.M. CAP	50V	100nF
C1602	ECUV1H104ZFX	S.M. CAP	50V	100nF
C1603	ECUV1H104ZFX	S.M. CAP	50V	100nF
C1604	ECUV1H104ZFX	S.M. CAP	50V	100nF
C1605	ECUV1H104ZFX	S.M. CAP	50V	100nF
C1606	ECUV1H104ZFX	S.M. CAP	50V	100nF
C1607	ECUV1H104ZFX	S.M. CAP	50V	100nF
C1608	ECUV1H104ZFX	S.M. CAP	50V	100nF
C1609	ECUV1H104ZFX	S.M. CAP	50V	100nF
C1610	ECUV1H104ZFX	S.M. CAP	50V	100nF
C1611	ECA1CM471GB	ELECT	16V	470µF
C1612	ECUV1H104ZFX	S.M. CAP	50V	100nF
C1614	ECUV1H104ZFX	S.M. CAP	50V	100nF
C1615	ECUV1H104ZFX	S.M. CAP	50V	100nF
C1616	ECUV1H104ZFX	S.M. CAP	50V	100nF
C1617	ECUV1H104ZFX	S.M. CAP	50V	100nF
C1618	ECUV1H104ZFX	S.M. CAP	50V	100nF
C1619	ECUV1H104ZFX	S.M. CAP	50V	100nF
C1620	ECUV1H104ZFX	S.M. CAP	50V	100nF
C1621	ECUV1H104ZFX	S.M. CAP	50V	100nF
C1622	ECUV1H104ZFX	S.M. CAP	50V	100nF
C1623	ECUV1H104ZFX	S.M. CAP	50V	100nF
C1624	ECUV1H104ZFX	S.M. CAP	50V	100nF
C1625	ECUV1H104ZFX	S.M. CAP	50V	100nF
C1626	ECUV1H104ZFX	S.M. CAP	50V	100nF
C1627	ECUV1H104ZFX	S.M. CAP	50V	100nF
C1628	ECUV1H104ZFX	S.M. CAP	50V	100nF
C1629	ECUV1H104ZFX	S.M. CAP	50V	100nF
C1630	ECUV1H104ZFX	S.M. CAP	50V	100nF
C1631	ECUV1H104ZFX	S.M. CAP	50V	100nF
C1632	ECUV1H104ZFX	S.M. CAP	50V	100nF
C1633	ECUV1H104ZFX	S.M. CAP	50V	100nF
C1636	ECUV1H104ZFX	S.M. CAP	50V	100nF
C1637	ECUV1H104ZFX	S.M. CAP	50V	100nF
C1638	ECUV1H104ZFX	S.M. CAP	50V	100nF
C1639	ECUV1H104ZFX	S.M. CAP	50V	100nF
C1642	ECUV1H104ZFX	S.M. CAP	50V	100nF
C1643	ECUV1H104ZFX	S.M. CAP	50V	100nF
C1644	ECUV1H104ZFX	S.M. CAP	50V	100nF
C1645	ECUV1H104ZFX	S.M. CAP	50V	100nF
C1647	ECUV1H470JCX	S.M. CAP	50V	47pF
C1648	ECUV1H104ZFX	S.M. CAP	50V	100nF
C1649	ECA1HM101GB	ELECT	50V	100µF
C1650	ECUV1H104ZFX	S.M. CAP	50V	100nF
C1651	ECUV1H104ZFX	S.M. CAP	50V	100nF
C1652	ECA1HM101GB	ELECT	50V	100µF
C1653	ECUV1H104ZFX	S.M. CAP	50V	100nF
C1654	ECUV1H104ZFX	S.M. CAP	50V	100nF
C1655	ECA1VM470B	ELECT	35V	47µF
C1656	ECUV1H104ZFX	S.M. CAP	50V	100nF
C1658	ECUV1H104ZFX	S.M. CAP	50V	100nF
C1659	ECA1VM470B	ELECT	35V	47µF
C1660	ECUV1H104ZFX	S.M. CAP	50V	100nF
C1661	ECA1HM101GB	ELECT	50V	100µF
C1662	ECUV1H104ZFX	S.M. CAP	50V	100nF

Cct Ref	Parts Number	Description		
C1663	ECUV1H560JCX	S.M. CAP	50V	56pF
C1664	ECUV1H104ZFX	S.M. CAP	50V	100nF
C1666	ECUV1H390JCX	S.M. CAP	50V	39pF
C1667	ECUV1H820JCX	S.M. CAP	50V	82pF
C1668	ECUV1H680JCX	S.M. CAP	50V	68pF
C1669	ECUV1H271JCX	S.M. CAP	50V	270pF
C1670	ECUV1H391JCX	S.M. CAP	50V	390pF
C1671	ECUV1H390JCX	S.M. CAP	50V	39pF
C1672	ECUV1H820JCX	S.M. CAP	50V	82pF
C1673	ECUV1H680JCX	S.M. CAP	50V	68pF
C1674	ECUV1H271JCX	S.M. CAP	50V	270pF
C1675	ECUV1H391JCX	S.M. CAP	50V	390pF
C1676	ECUV1H390JCX	S.M. CAP	50V	39pF
C1677	ECUV1H820JCX	S.M. CAP	50V	82pF
C1678	ECUV1H680JCX	S.M. CAP	50V	68pF
C1679	ECUV1H271JCX	S.M. CAP	50V	270pF
C1680	ECUV1H391JCX	S.M. CAP	50V	390pF
C1681	ECUV1H820JCX	S.M. CAP	50V	82pF
C1682	ECUV1H104ZFX	S.M. CAP	50V	100nF
C1683	ECUV1H101JCX	S.M. CAP	50V	100pF
C1685	ECUV1H104ZFX	S.M. CAP	50V	100nF
C1686	ECUV1H101JCX	S.M. CAP	50V	100pF
C1688	ECUV1H104ZFX	S.M. CAP	50V	100nF
C1689	ECUV1H104ZFX	S.M. CAP	50V	100nF
C1690	ECJ2VF1C105Z	ELECT	350V	1µF
C1691	ECJ2VF1C105Z	ELECT	350V	1µF
C1692	EEUNA1E220B	CERAMIC	25V	22µF
C1693	ECA1HM101GB	ELECT	50V	100µF
C1695	ECUV1H221JCX	S.M. CAP	50V	220pF
C1696	EEUNA1E220B	CERAMIC	25V	22µF
C1697	EEUNA1E220B	CERAMIC	25V	22µF
C1698	EEUNA1E220B	CERAMIC	25V	22µF
C1903	ECA1EM470GB	ELECT	25V	47µF
C1904	ECUV1H103ZFX	S.M. CAP	50V	10nF
C1905	ECUV1C224KBX	S.M. CAP	16V	220nF
C2103	ECUV1H391KBX	S.M. CAP	50V	390pF
C2104	ECUV1H102KBX	S.M. CAP	50V	1nF
C2105	ECUV1H102KBX	S.M. CAP	50V	1nF
C2106	ECUV1H102KBX	S.M. CAP	50V	1nF
C2107	ECUV1H102KBX	S.M. CAP	50V	1nF
C2108	ECUV1H102KBX	S.M. CAP	50V	1nF
C2109	ECUV1H102KBX	S.M. CAP	50V	1nF
C2110	ECUV1H102KBX	S.M. CAP	50V	1nF
C2111	ECA1CM100GB	ELECT	16V	10µF
C2112	ECUV1H104ZFX	S.M. CAP	50V	100nF
C2113	ECA1CM100GB	ELECT	16V	10µF
C2114	ECA1HM101GB	ELECT	50V	100µF
C2115	ECUV1H104ZFX	S.M. CAP	50V	100nF
C2116	ECUV1H102KBX	S.M. CAP	50V	1nF
C2117	ECUV1H471KBX	S.M. CAP	50V	470pF
C2118	ECA1HM3R3GB	ELECT	50V	3.3µF
C2119	ECUV1H471KBX	S.M. CAP	50V	470pF
C2120	ECUV1H104ZFX	S.M. CAP	50V	100nF
C2121	ECUV1H221JCX	S.M. CAP	50V	220pF
C2122	ECUV1H221JCX	S.M. CAP	50V	220pF
C2123	ECUV1H221JCX	S.M. CAP	50V	220pF
C2124	ECUV1H104ZFX	S.M. CAP	50V	100nF
C2125	ECA1CM100GB	ELECT	16V	10µF
C2126	ECUV1H221JCX	S.M. CAP	50V	220pF
C2127	ECUV1H104ZFX	S.M. CAP	50V	100nF
C2128	ECUV1H221JCX	S.M. CAP	50V	220pF
C2129	ECA1CM100GB	ELECT	16V	10µF
C2130	ECUV1H221JCX	S.M. CAP	50V	220pF
C2131	ECQM1H334J	FILM	50V	330nF
C2132	ECEA1HKA100	ELECT	50V	10pF
C2133	ECUV1H470JCX	S.M. CAP	50V	47pF



Cct Ref	Parts Number	Description		
C2134	ECUV1H470JCX	S.M. CAP	50V	47pF
C2135	ECUV1H070DCX	S.M. CAP	50V	7pF
C2137	ECUV1H104ZFX	S.M. CAP	50V	100nF
C2138	ECUV1H010CCX	S.M. CAP	50V	1pF
C2139	ECUV1H010CCX	S.M. CAP	50V	1pF
C2141	ECUV1H560JCX	S.M. CAP	50V	56pF
C2142	ECA1CM100GB	ELECT	16V	10µF
C2144	ECUV1H560JCX	S.M. CAP	50V	56pF
C2146	ECEA1HKA100	ELECT	50V	10pF
C2147	ECUV1H103KBX	S.M. CAP	50V	10nF
C2148	ECUV1H103KBX	S.M. CAP	50V	10nF
C2200	ECUV1H562KBX	S.M. CAP	50V	5.6nF
C2201	ECA1HM100GB	ELECT	50V	10µF
C2202	ECA1HM2R2GB	ELECT	50V	2.2µF
C2203	ECA1VM470B	ELECT	35V	47µF
C2204	ECA1HM4R7GB	ELECT	50V	4.7µF
C2205	ECUV1H562KBX	S.M. CAP	50V	5.6nF
C2206	ECA1HM2R2GB	ELECT	50V	2.2µF
C2207	ECUV1H822KBX	S.M. CAP	50V	8.2nF
C2208	ECUV1H823KBX	S.M. CAP	50V	82nF
C2209	ECUV1H681JCX	S.M. CAP	50V	680pF
C2211	ECUV1C104KBX	S.M. CAP	16V	100nF
C2212	ECUV1C104KBX	S.M. CAP	16V	100nF
C2214	ECUV1C154KBX	S.M. CAP	16V	150nF
C2215	ECUV1H103KBX	S.M. CAP	50V	10nF
C2216	ECCR1H121J	CERAMIC	50V	120pF
C2217	ECCR1H121J	CERAMIC	50V	120pF
C2220	ECUV1H562KBX	S.M. CAP	50V	5.6nF
C2221	ECA1HM100GB	ELECT	50V	10µF
C2222	ECA1HM2R2GB	ELECT	50V	2.2µF
C2223	ECA1VM470B	ELECT	35V	47µF
C2224	ECA1HM4R7GB	ELECT	50V	4.7µF
C2225	ECUV1H562KBX	S.M. CAP	50V	5.6nF
C2226	ECA1HM2R2GB	ELECT	50V	2.2µF
C2227	ECUV1H822KBX	S.M. CAP	50V	8.2nF
C2228	ECUV1H823KBX	S.M. CAP	50V	82nF
C2229	ECUV1H681JCX	S.M. CAP	50V	680pF
C2231	ECUV1C104KBX	S.M. CAP	16V	100nF
C2232	ECUV1C104KBX	S.M. CAP	16V	100nF
C2234	ECUV1C154KBX	S.M. CAP	16V	150nF
C2235	ECUV1H103KBX	S.M. CAP	50V	10nF
C2240	ECA1CM470GB	ELECT	16V	47µF
C2242	ECA1CM471GB	ELECT	16V	47µF
C2301	ECA1CM470GB	ELECT	16V	47µF
C2302	ECA1CM470GB	ELECT	16V	47µF
C2307	ECUV1H103KBX	S.M. CAP	50V	10nF
C2308	ECUV1H103KBX	S.M. CAP	50V	10nF
C2353	ECA1CM471GB	ELECT	16V	47µF
C2356	ECA1HM4R7GB	ELECT	50V	4.7µF
C2357	ECUV1H151JCX	S.M. CAP	50V	150pF
C2358	ECUV1H151JCX	S.M. CAP	50V	150pF
C2359	ECA1HM4R7GB	ELECT	50V	4.7µF
C2361	ECA1CM470GB	ELECT	16V	47µF
C2362	ECA1HM101GB	ELECT	50V	100µF
C2363	ECEA1HU221	ELECT	50V	220µF
C2364	ECEA1HU221	ELECT	50V	220µF
C2365	ECA1HM101GB	ELECT	50V	100µF
C2366	ECA0JM222GB	ELECT	6.3V	2.2nF
C2367	ECUV1H104ZFX	S.M. CAP	50V	100nF
C2370	ECA1HM100GB	ELECT	50V	10µF
C2371	ECUV1H472KBX	S.M. CAP	50V	4.7nF
C2372	ECUV1H472KBX	S.M. CAP	50V	4.7nF
C2375	ECUV1H104ZFX	S.M. CAP	50V	100nF
C2377	ECUV1H102JCX	S.M. CAP	50V	1nF
C2378	ECUV1H102JCX	S.M. CAP	50V	1nF
C2381	ECKC1H103JB	CERAMIC	50V	10nF

Cct Ref	Parts Number	Description		
C2382	ECKC1H103JB	CERAMIC	50V	10nF
C2401	ECUV1H102KBX	S.M. CAP	50V	1nF
C2402	ECUV1H102KBX	S.M. CAP	50V	1nF
C2403	ECUV1H332KBX	S.M. CAP	50V	3.3nF
C2404	ECUV1H332KBX	S.M. CAP	50V	3.3nF
C2408	ECEA1CKA100	ELECT	16V	10µF
C2410	ECA1EM471GB	ELECT	25V	470µF
C2412	ECEA1HKA010	ELECT	50V	1µF
C2413	ECEA1CKA101	ELECT	16V	100µF
C2414	ECUV1H150JCX	S.M. CAP	50V	15pF
C2415	ECUV1H150JCX	S.M. CAP	50V	15pF
C2416	EEANA1E1R0B	CERAMIC	35V	0R1µF
C2417	EEANA1E1R0B	CERAMIC	35V	0R1µF
C2418	EEANA1E1R0B	CERAMIC	35V	0R1µF
C2419	EEANA1E1R0B	CERAMIC	35V	0R1µF
C2420	ECUV1H150JCX	S.M. CAP	50V	15pF
C2421	ECUV1H150JCX	S.M. CAP	50V	15pF
C2422	ECUV1H561JCX	S.M. CAP	50V	560pF
C2423	ECUV1H561JCX	S.M. CAP	50V	560pF
C2424	ECUV1H561JCX	S.M. CAP	50V	560pF
C2425	ECUV1H561JCX	S.M. CAP	50V	560pF
C2427	ECUV1H561JCX	S.M. CAP	50V	560pF
C2428	ECUV1H561JCX	S.M. CAP	50V	560pF
C2430	ECUV1H561JCX	S.M. CAP	50V	560pF
C2431	ECUV1H561JCX	S.M. CAP	50V	560pF
C2432	ECEA1HKA010	ELECT	50V	1µF
C2433	ECEA1HKA010	ELECT	50V	1µF
C2434	ECEA1HKA010	ELECT	50V	1µF
C2435	ECEA1HKA010	ELECT	50V	1µF
C2436	ECEA1HKA010	ELECT	50V	1µF
C2437	ECUV1H561JCX	S.M. CAP	50V	560pF
C2438	ECUV1H561JCX	S.M. CAP	50V	560pF
C2439	ECEA1HKA010	ELECT	50V	1µF
C2440	ECUV1H222KBX	S.M. CAP	50V	2.2nF
C2441	ECUV1H222KBX	S.M. CAP	50V	2.2nF
C2442	ECUV1H222KBX	S.M. CAP	50V	2.2nF
C2443	ECUV1H222KBX	S.M. CAP	50V	2.2nF
C2444	ECUV1H222KBX	S.M. CAP	50V	2.2nF
C2445	ECUV1H222KBX	S.M. CAP	50V	2.2nF
C2446	ECUV1H561JCX	S.M. CAP	50V	560pF
C2447	ECUV1H561JCX	S.M. CAP	50V	560pF
C2448	EEANA1E1R0B	CERAMIC	35V	0R1µF
C2449	EEANA1E1R0B	CERAMIC	35V	0R1µF
C2450	ECUV1H150JCX	S.M. CAP	50V	15pF
C2451	ECUV1H150JCX	S.M. CAP	50V	15pF
C2452	ECUV1H103ZFX	S.M. CAP	50V	10nF
C2463	ECUV1H102KBX	S.M. CAP	50V	1nF
C2464	ECUV1H102KBX	S.M. CAP	50V	1nF
C2501	ECA1HM101GB	ELECT	50V	100µF
C2502	ECA1HM010GB	ELECT	50V	1µF
C2503	ECA1HM010GB	ELECT	50V	1µF
C2504	ECUV1H010CCX	S.M. CAP	50V	1pF
C2505	ECUV1H104ZFX	S.M. CAP	50V	100nF
C2506	ECA1HM3R3GB	ELECT	50V	3.3µF
C2507	ECA1CM100GB	ELECT	16V	10µF
C2508	ECA1CM100GB	ELECT	16V	10µF
C2509	ECUV1H010CCX	S.M. CAP	50V	1pF
C2510	ECUV1H104ZFX	S.M. CAP	50V	100nF
C2511	ECUV1H104ZFX	S.M. CAP	50V	100nF
C2513	ECUV1H104ZFX	S.M. CAP	50V	100nF
C2514	ECUV1H102KBX	S.M. CAP	50V	1nF
C2515	ECUV1H104ZFX	S.M. CAP	50V	100nF
C2517	ECUV1H102KBX	S.M. CAP	50V	1nF
C2518	ECA1HM010GB	ELECT	50V	1µF
C2520	ECJ2VF1C334Z	ELECT	350V	330nF
C2521	ECJ2VF1C334Z	ELECT	350V	330nF

Cct Ref	Parts Number	Description			
C2522	ECJ2VF1C334Z	ELECT	350V	330nF	
C2523	ECJ2VF1C334Z	ELECT	350V	330nF	
C2524	ECJ2VF1C334Z	ELECT	350V	330nF	
C2526	ECA1CM100GB	ELECT	16V	10µF	
C2527	ECJ2VF1C334Z	ELECT	350V	330nF	
C2528	ECJ2VF1C334Z	ELECT	350V	330nF	
C2529	ECKC1H102J	CERAMIC	50V	1nF	
C2530	ECQM1H274J	FILM	50V	270nF	
C2532	ECA1VM102GB	ELECT	35V	1nF	
C2542	ECA1VM102GB	ELECT	35V	1nF	
C2552	ECOS2GA101BB	ELECT	400V	100µF	
C2553	ECA1CM221GB	ELECT	16V	220µF	
C2554	ECQM1H104J	FILM	50V	100nF	
C2555	ECKC3D471JB	CERAMIC	2KV	470pF	△
C2556	ECA1CM221GB	ELECT	16V	220µF	
C2557	ECQB1H333J	FILM	50V	33nF	
C2558	ECQB1H683K	FILM	50V	68nF	
C2559	ECKC2H103J	CERAMIC	50V	10nF	△
C2569	ECKC2H471J	CERAMIC	500V	470pF	△
C2572	EEUFC1E331B	CERAMIC	25V	330pF	
C2573	ECA1HHG102B	ELECT	50V	1µF	
C2610	ECA1HM010GB	ELECT	50V	1µF	
C2612	ECUV1H223KBX	S.M. CAP	50V	22nF	
C2615	ECA1HM010GB	ELECT	50V	1µF	
C2618	ECQB1H153K	FILM	50V	15nF	
C2619	ECQB1H153K	FILM	50V	15nF	
C2620	ECA1HM010GB	ELECT	50V	1µF	
C2621	ECA1HM010GB	ELECT	50V	1µF	
C2622	ECUV1H223KBX	S.M. CAP	50V	22nF	
C2623	ECQM1H474J	FILM	50V	470nF	
C2624	ECQM1H474J	FILM	50V	470nF	
C2625	ECQM1H474J	FILM	50V	470nF	
C2626	ECQM1H474J	FILM	50V	470nF	
C2627	ECQM1H474J	FILM	50V	470nF	
C2628	ECEA1HN010UB	ELECT	50V	1µF	
C2629	ECEA1HN010UB	ELECT	50V	1µF	
C2631	ECUV1H101JCX	S.M. CAP	50V	100pF	
C2632	ECA1HM330B	ELECT	50V	33µF	
C2633	ECUV1H103ZFX	S.M. CAP	50V	10nF	
C2634	ECA1HM010GB	ELECT	50V	1µF	
C2635	ECUV1H222KBX	S.M. CAP	50V	2.2nF	
C2636	ECA1HM010GB	ELECT	50V	1µF	
C2637	ECUV1H103ZFX	S.M. CAP	50V	10nF	
C2638	ECQM1H474J	FILM	50V	470nF	
C2639	ECUV1H102KBX	S.M. CAP	50V	1nF	
C2641	ECUV1H101JCX	S.M. CAP	50V	100pF	
C2642	ECA1HM330B	ELECT	50V	33µF	
C2643	ECUV1H103ZFX	S.M. CAP	50V	10nF	
C2644	ECA1HM010GB	ELECT	50V	1µF	
C2645	ECUV1H222KBX	S.M. CAP	50V	2.2nF	
C2646	ECA1HM010GB	ELECT	50V	1µF	
C2647	ECUV1H103ZFX	S.M. CAP	50V	10nF	
C2648	ECQM1H474J	FILM	50V	470nF	
C2649	ECUV1H102KBX	S.M. CAP	50V	1nF	
C2650	ECUV1H272JCX	S.M. CAP	50V	2.7nF	
C2651	ECUV1H101JCX	S.M. CAP	50V	100pF	
C2652	ECA1HM330B	ELECT	50V	33µF	
C2653	ECUV1H103ZFX	S.M. CAP	50V	10nF	
C2654	ECA1HM010GB	ELECT	50V	1µF	
C2655	ECUV1H222KBX	S.M. CAP	50V	2.2nF	
C2656	ECA1HM010GB	ELECT	50V	1µF	
C2657	ECUV1H103ZFX	S.M. CAP	50V	10nF	
C2658	ECQM1H474J	FILM	50V	470nF	
C2660	ECUV1H272JCX	S.M. CAP	50V	2.7nF	
C2661	ECUV1H101JCX	S.M. CAP	50V	100pF	
C2662	ECA1HM330B	ELECT	50V	33µF	

Cct Ref	Parts Number	Description			
C2663	ECUV1H103ZFX	S.M. CAP	50V	10nF	
C2664	ECA1HM010GB	ELECT	50V	1µF	
C2665	ECUV1H222KBX	S.M. CAP	50V	2.2nF	
C2666	ECA1HM010GB	ELECT	50V	1µF	
C2667	ECUV1H103ZFX	S.M. CAP	50V	10nF	
C2668	ECQM1H474J	FILM	50V	470nF	
C2671	ECA1HM100GB	ELECT	50V	10µF	
C2672	ECA1HM010GB	ELECT	50V	1µF	
C2675	ECUV1H224ZFX	S.M. CAP	50V	220nF	
C2676	ECA1HM010GB	ELECT	50V	1µF	
C2678	ECQM1H474J	FILM	50V	470nF	
C2679	ECA1VM102GB	ELECT	35V	1nF	
C2683	ECUV1H561JCX	S.M. CAP	50V	560pF	
C2684	ECUV1H561JCX	S.M. CAP	50V	560pF	
C2685	ECUV1H561JCX	S.M. CAP	50V	560pF	
C2686	ECUV1H561JCX	S.M. CAP	50V	560pF	
C2687	ECUV1H102KBX	S.M. CAP	50V	1nF	
C3001	ECUV1H103ZFX	S.M. CAP	50V	10nF	
C3002	ECA1CM470GB	ELECT	16V	47µF	
C3003	ECUV1H102ZFX	S.M. CAP	50V	1nF	
C3004	ECUV1H104ZFX	S.M. CAP	50V	100nF	
C3005	ECUV1H104ZFX	S.M. CAP	50V	100nF	
C3006	ECA1HM4R7GB	ELECT	50V	4.7µF	
C3007	ECA1HM4R7GB	ELECT	50V	4.7µF	
C3008	ECUV1H104ZFX	S.M. CAP	50V	100nF	
C3009	ECUV1H473ZFX	S.M. CAP	50V	47nF	
C3010	ECUV1H680JCX	S.M. CAP	50V	68pF	
C3011	ECA1CM221GB	ELECT	16V	220µF	
C3012	ECA1CM470GB	ELECT	16V	47µF	
C3013	ECA1CM470GB	ELECT	16V	47µF	
C3014	EEUNA1A470B	CERAMIC	10V	47µF	
C3015	ECUV1H104ZFX	S.M. CAP	50V	100nF	
C3016	ECA1CM470GB	ELECT	16V	47µF	
C3017	ECUV1H104ZFX	S.M. CAP	50V	100nF	
C3018	ECUV1H104ZFX	S.M. CAP	50V	100nF	
C3019	ECUV1H104ZFX	S.M. CAP	50V	100nF	
C3020	ECUV1H104ZFX	S.M. CAP	50V	100nF	
C3021	ECA1CM331B	ELECT	16V	330µF	
C3022	ECA1CM102B	ELECT	16V	1000µF	
C3023	ECA1HM100GB	ELECT	50V	10µF	
C3024	ECA1HM2R2GB	ELECT	50V	2.2µF	
C3025	ECA1CM470GB	ELECT	16V	47µF	
C3027	ECJ2VF1H104Z	ELECT	350V	100nF	
C3028	ECUV1H470JRX	S.M. CAP	50V	47pF	
C3120	ECUV1H103KBX	S.M. CAP	50V	10nF	
C3122	ECUV1H102KBX	S.M. CAP	50V	1nF	
C3123	ECUV1H103KBX	S.M. CAP	50V	10nF	
C3124	ECUV1H102KBX	S.M. CAP	50V	1nF	
C3255	ECA1HM4R7GB	ELECT	50V	4.7µF	
C3256	ECA1HM4R7GB	ELECT	50V	4.7µF	
C3282	ECKC1H561J	CERAMIC	50V	560pF	
C3284	ECKC1H561J	CERAMIC	50V	560pF	
C3351	ECA1CM221GB	ELECT	16V	220µF	
C3401	ECEA1HKA100	ELECT	50V	10pF	
C3402	ECUV1H561JCX	S.M. CAP	50V	560pF	
C3403	ECUV1H561JCX	S.M. CAP	50V	560pF	
C3404	ECUV1H561JCX	S.M. CAP	50V	560pF	
C3405	ECUV1H561JCX	S.M. CAP	50V	560pF	
C3406	ECUV1H561JCX	S.M. CAP	50V	560pF	
C3407	ECUV1H561JCX	S.M. CAP	50V	560pF	
C3408	ECUV1H561JCX	S.M. CAP	50V	560pF	
C3409	ECEA1HKA4R7	ELECT	50V	4.7µF	
C3410	ECEA1HKA100	ELECT	50V	10pF	
C3411	ECUV1H561JCX	S.M. CAP	50V	560pF	
C3412	ECEA1HKA4R7	ELECT	50V	4.7µF	
C3413	ECUV1H102JCX	S.M. CAP	50V	1nF	

Cct Ref	Parts Number	Description		
C3414	ECEA1HKA100	ELECT	50V	10pF
C3415	ECEA1HKA100	ELECT	50V	10pF
C3416	ECEA1HKA4R7	ELECT	50V	4.7µF
C3417	ECEA1HKA100	ELECT	50V	10pF
C3418	ECEA1HKA100	ELECT	50V	10pF
C3419	ECUV1H561JCX	S.M. CAP	50V	560pF
C3420	ECUV1H561JCX	S.M. CAP	50V	560pF
C3421	ECUV1H561JCX	S.M. CAP	50V	560pF
C3422	ECUV1H561JCX	S.M. CAP	50V	560pF
C3423	ECUV1H561JCX	S.M. CAP	50V	560pF
C3424	ECUV1H561JCX	S.M. CAP	50V	560pF
C3425	ECUV1H561JCX	S.M. CAP	50V	560pF
C3426	ECUV1H561JCX	S.M. CAP	50V	560pF
C3427	ECUV1H102JCX	S.M. CAP	50V	1nF
C3428	ECEA1HKA4R7	ELECT	50V	4.7µF
C3429	ECEA1CKA220	ELECT	16V	22µF
C3430	ECEA1HKA4R7	ELECT	50V	4.7µF
C3431	ECEA1CN470	ELECT	16V	47µF
C3432	ECUV1H104ZFX	S.M. CAP	50V	100nF
C3433	ECA1CM221GB	ELECT	16V	220µF
C3434	ECUV1H561JCX	S.M. CAP	50V	560pF
C3435	ECEA1HKA100	ELECT	50V	10pF
C3436	ECUV1H561JCX	S.M. CAP	50V	560pF
C3437	ECUV1H561JCX	S.M. CAP	50V	560pF
C3438	ECEA1HKA4R7	ELECT	50V	4.7µF
C3439	ECUV1H561JCX	S.M. CAP	50V	560pF
C3440	ECUV1H561JCX	S.M. CAP	50V	560pF
C3441	ECEA1HKA100	ELECT	50V	10pF
C3442	ECUV1H561JCX	S.M. CAP	50V	560pF
C3443	ECUV1H561JCX	S.M. CAP	50V	560pF
C3444	ECEA1HKA4R7	ELECT	50V	4.7µF
C3445	ECUV1H102JCX	S.M. CAP	50V	1nF
C3446	ECEA1HKA4R7	ELECT	50V	4.7µF
C3447	ECUV1H561JCX	S.M. CAP	50V	560pF
C3460	ECUV1H561JCX	S.M. CAP	50V	560pF
C3496	ECUV1H561JCX	S.M. CAP	50V	560pF
C3498	ECUV1H561JCX	S.M. CAP	50V	560pF
C3802	ECA1CM100GB	ELECT	16V	10µF
C3803	ECA1EM100GB	ELECT	25V	0.1µF
C3804	ECUV1H104ZFX	S.M. CAP	50V	100nF
C3805	ECUV1H224ZFX	S.M. CAP	50V	220nF
C3806	ECA1HM101GB	ELECT	50V	100µF
C3807	ECA1HM100GB	ELECT	50V	10µF
C3808	ECA1CM470GB	ELECT	16V	47µF
C3810	ECUV1H103KBX	S.M. CAP	50V	10nF
C3814	ECA1HM010GB	ELECT	50V	1µF
C3816	ECA1CM471GB	ELECT	16V	470µF
C3817	ECA1CM221GB	ELECT	16V	220µF
C3818	ECUV1H103KBX	S.M. CAP	50V	10nF
C3819	ECA1HM010GB	ELECT	50V	1µF
C3821	ECA1HM010GB	ELECT	50V	1µF
C3823	ECUV1H104ZFX	S.M. CAP	50V	100nF
C3824	ECUV1H103KBX	S.M. CAP	50V	10nF
C3825	ECJ2VB1C224K	ELECT	350V	220nF
C3827	ECUV1H224ZFX	S.M. CAP	50V	220nF
C3909	ECQB1H153K	FILM	50V	15nF
C3910	ECA1HM010GB	ELECT	50V	1µF
C3911	ECQB1H153K	FILM	50V	15nF
C3912	ECQM1222JZ	FILM	100V	2.2nF
C3913	ECQV1H105JZ	FILM	50V	1µF
C3914	ECA1CM331B	ELECT	16V	330µF
C3915	ECQB1H103J	FILM	50V	10nF
C3916	ECQB1H104J	FILM	50V	100nF
C3917	ECQB1H683K	FILM	50V	68nF
C3918	ECQB1H222J	FILM	50V	2.2nF
C3919	ECQB1H333J	FILM	50V	33nF

Cct Ref	Parts Number	Description		
C3920	ECQB1H332K	FILM	50V	3.3nF
C3921	ECKC3A152J	CERAMIC	1KV	1500pF
C3922	ECKC3A182J	CERAMIC	1KV	1800pF
C3923	ECEA1HN100UB	ELECT	50V	10µF
C3924	ECKC3A122J	CERAMIC	1KV	1.2nF
C3925	ECKC3A151J	CERAMIC	1KV	150pF
C3926	ECKC3A681J	CERAMIC	1KV	680pF
C3927	ECA1HM010GB	ELECT	50V	1µF
C3928	ECQM4223JZV	FILM	400V	22nF
C3929	ECQM4223JZV	FILM	400V	22nF
C3931	ECKC3D101J	CERAMIC	2KV	100pF
C3932	ECUV1H103KBX	S.M. CAP	50V	10nF
C3933	ECKC3A471J	CERAMIC	1KV	470pF
C3936	ECA2CM330B	ELECT	160V	33µF
C3937	ECQM1H104J	FILM	50V	100nF
C3939	ECA1HM3R3GB	ELECT	50V	3.3µF
C3940	ECA1CMH471B	ELECT	16V	470µF
C3941	ECA1HMH47B	ELECT	50V	470µF
C3942	ECEA1HN010UB	ELECT	50V	1µF
C3943	ECUV1H101JCX	S.M. CAP	50V	100pF
C3944	ECQB1H103J	FILM	50V	10nF
C3945	ECA1HM100GB	ELECT	50V	10µF
C3946	ECQB1H333J	FILM	50V	33nF
C3947	ECKC3D102J	CERAMIC	2KV	1nF
C3948	ECQV1H105JZ	FILM	50V	1µF
C3955	ECQB1H563K	FILM	50V	56nF
R2682	ECUV1H104KBX	S.M. CAP	50V	100nF
<b>TERMINALS AND LINKS</b>				
JK2401	TJB8E018	PUSH TERMINAL		
JK2402	TJB8E015	RCA TERMINAL(3P)		
JK2403	TJB8E015	RCA TERMINAL(3P)		
JK2551	TJB18924-1	PUSH TERMINAL		
JK3281	TJB16656	A.V. TERMINAL		
JK3401	0350536400	SCART SOCKET		
JK3402	0350536400	SCART SOCKET		
JK3403	0350536400	SCART SOCKET		
R847	TSF19252	FS LINK		
R848	TSF19402	FS LINK		
R1914	TSF19501	FS LINK		
R2557	TSF19252	FS LINK		
R2567	TSF19402	FS LINK		
R2568	TSF19252	FS LINK		
<b>SWITCHES</b>				
S840	ESB92S11B	SWITCH		
S1071	EVQ23405R	SWITCH		
S1072	EVQ23405R	SWITCH		
S1073	EVQ23405R	SWITCH		
S1074	EVQ23405R	SWITCH		
S1075	EVQ23405R	SWITCH		

## SCHEMATIC DIAGRAMS FOR MODEL

TX-33AK10F

(EURO-5 CHASSIS)

### IMPORTANT SAFETY NOTICE



Components identified by  mark have special characteristics important for safety. When replacing any of these components, use only manufacturer's specified parts.

### NOTES



- RESISTOR**  
All resistors are carbon 1/4W resistor, unless marked otherwise.  
Unit of resistance is OHM ( $\Omega$ ) (k=1,000, M=1,000,000)
- CAPACITORS**  
All capacitors are ceramic 50V unless marked otherwise  
Unit of capacitance is  $\mu$ F unless otherwise stated.
- COIL**  
Unit of inductance is  $\mu$ H, unless otherwise stated.
- Components marked "L" on the schematic diagram shows leadless parts.
- TEST POINT**



Test Point Position

- EARTH SYMBOL**  
 Chassis Earth (Cold)  Line Earth (Hot)

- VOLTAGE MEASUREMENT**  
Voltage is measured by a d.c. voltmeter  
Measurement conditions are as follows:  
Power source a.c. 220V-240V, 50Hz  
Receiving Signal Colour Bar signal (RF)  
All customer controls Maximum position

-  Indicates the Video signal path  
 Indicates the Audio signal path

These schematic diagrams are the latest at time of printing and are subject to change without notice.

### REMARKS

- The Power Supply Circuit contains a circuit area which uses a separate power supply to isolate the earth connection. The circuit is defined by HOT and COLD indications in the schematic diagram. All circuits except the Power Circuit, are COLD. Take the following precautions :-
  - Do not touch the hot part, or the hot and cold parts at the same time, as you are liable to a shock hazard.
  - Do not short circuit the hot and cold circuits as electrical components may be damaged.
  - Do not connect an instrument, such as an oscilloscope, to the hot and cold circuits simultaneously as this may cause fuse failure. Connect the earth of the instruments to the earth connection of the circuit being measured.
  - Make sure to disconnect the power plug before removing the chassis.

## ZEICHENERKLÄRUNG FÜR MODELL

TX-33AK10F

(EURO-5 CHASSIS)

### WICHTIGER SICHERHEITSHINWEIS

Teile, die mit einem Hinweis  gekennzeichnet sind, sind wichtig für die Sicherheit. Sollte ein Auswechseln erforderlich sein, sind unbedingt Originalteile einzusetzen.

### ANMERKUNG

- WIDERSTÄNDE**  
Alle 1/4W Widerstände sind Kohlewiderstände, Abweichungen sind folgt gekennzeichnet.  
Die Maßeinheit ist OHM ( $\Omega$ ) (k=1,000, M=1,000,000)
- KONDENSATOREN**  
Alle Kondensatoren sind Keramikausführungen. Spannungsfestigkeit 50V. Abweichungen sind wie folgt gekennzeichnet. Die Maßeinheit ist  $\mu$ F, wenn keine anderen Bezeichnungen genannt sind.
- SPULEN**  
Die Maßeinheit ist  $\mu$ H, Abweichungen sind gekennzeichnet.
- Mit "L" gekennzeichnete Teile sind ohne Anschlußdrähte.
- TESTPUNKTE**



Kennzeichnung der Testpunktposition

- MASSE SYMBOL**  
 Erdung am Chassis  Erdung an Masse-Leitung

- SPANNUNGSMESSUNG**  
Spannungsmessungen sind mit einem d.c.-Voltmeter durchzuführen. Die Meßbedingungen sind folgende:  
Netzspannung a.c. 220V-240V, 50Hz  
Wiedergabe Signal Farbbalken-Testbild  
Wiedergabesignal Farbbalken-Testbild (HF)

-  Videosignalweg  
 Audiosignalweg

- Änderungen im Laufe der Fertigung sind möglich.

### BEMERKUNGEN

- Das Schaltnetzteil enthält Bereiche, die direkt mit dem Netz verbunden sind. Diese Bereiche sind im Schaltplan mit HOT gekennzeichnet. Alle anderen Schaltungen sind mit COLD gekennzeichnet und haben keine direkte Verbindung mit dem Netz :-
  - Weder die Leitungen im heißen noch Leitungen im heißen und im kalten Bereich gleichzeitig berühren. Es besteht die Gefahr eines elektrischen Schlages.
  - Keinesfalls die Leitungen im heißen Bereich mit denen im kalten Bereich verbinden oder kurzschliessen. Dies kann zur Zerstörung von Bauteilen oder Sicherungen führen. Außerdem ist die elektrische Betriebssicherheit des Gerätes nicht mehr gegeben.
  - Keine Messinstrumente gleichzeitig an Leitungen im heißen und kalten Bereich anschliessen. Sicherungen könnten zerstört werden. Die Erde des Messinstrumentes immer mit der des zu prüfenden Schaltkreises verbinden.
  - Vor Ausbau des Chassis, Stecker aus der Netzsteckdose ziehen.

# JK3281

TJB16656

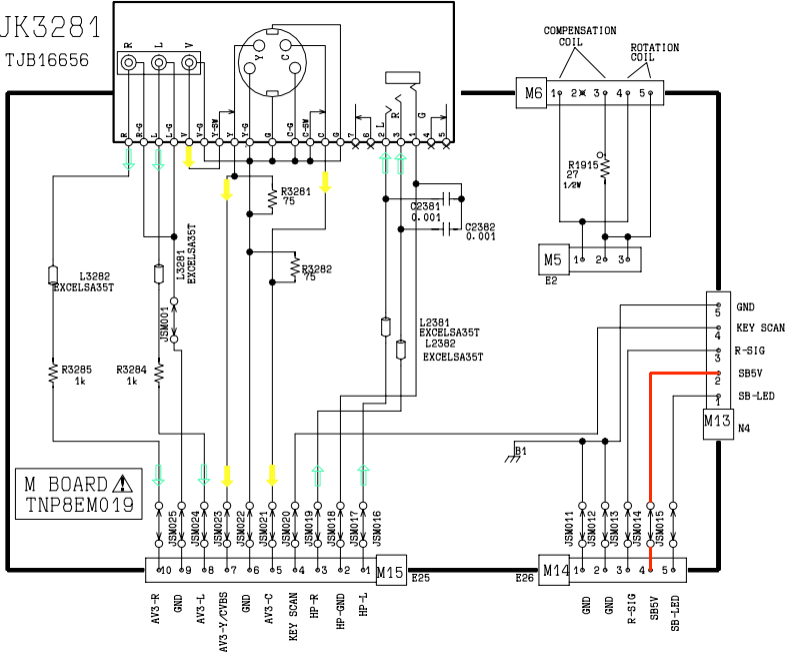

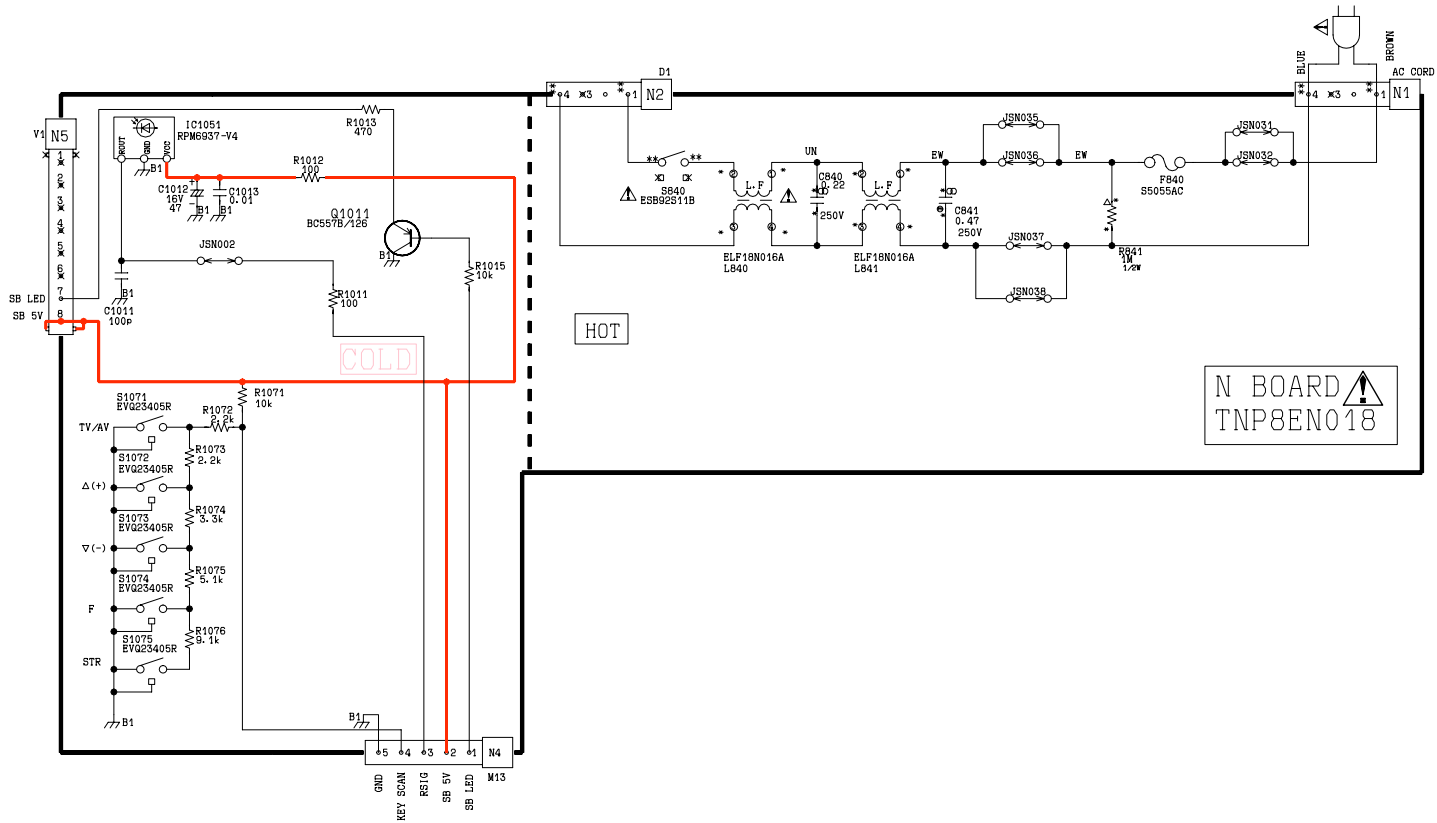

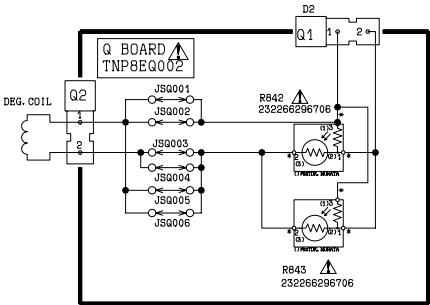

Z BOARD  
TNP8EZ001

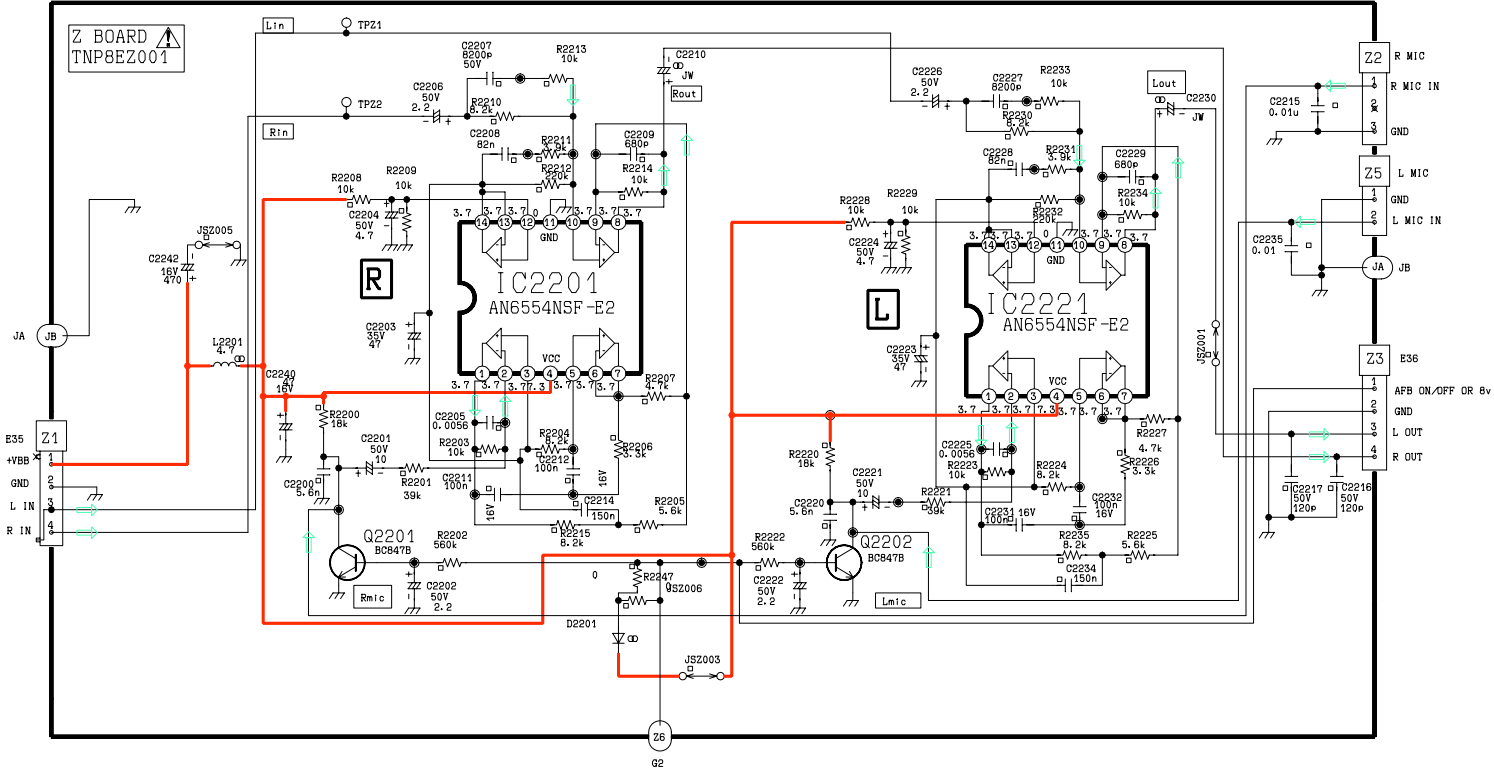





G BOARD  
TNPA0877

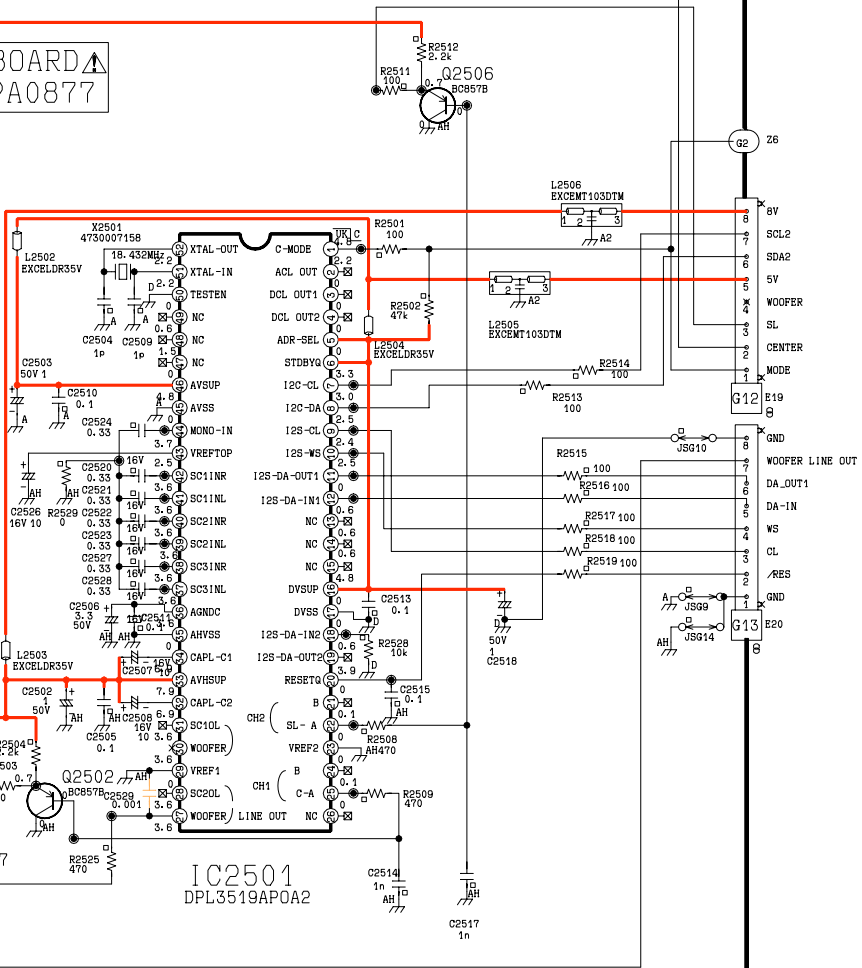

K BOARD  
TNPA1046

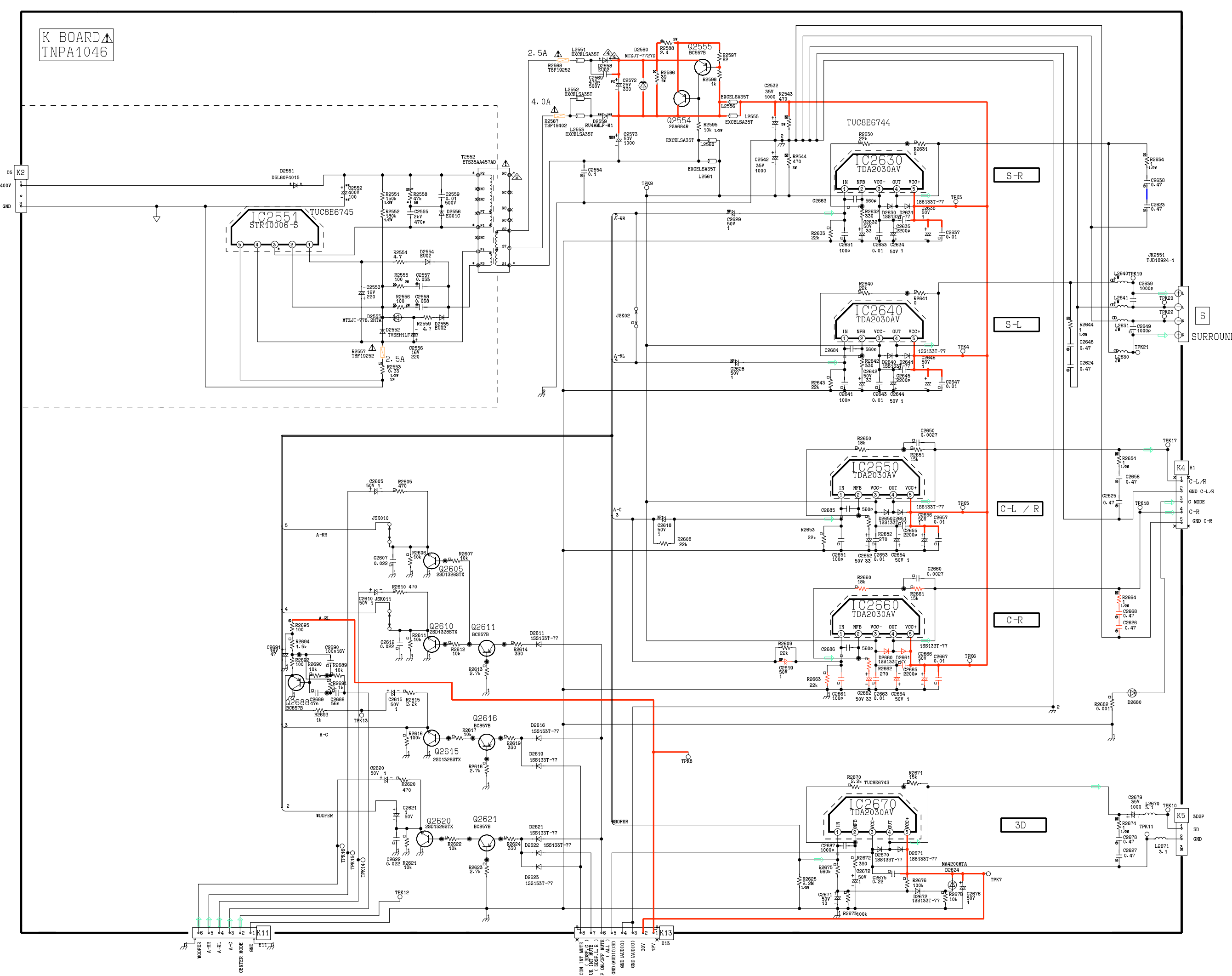



Y BOARD  
TNPA1353

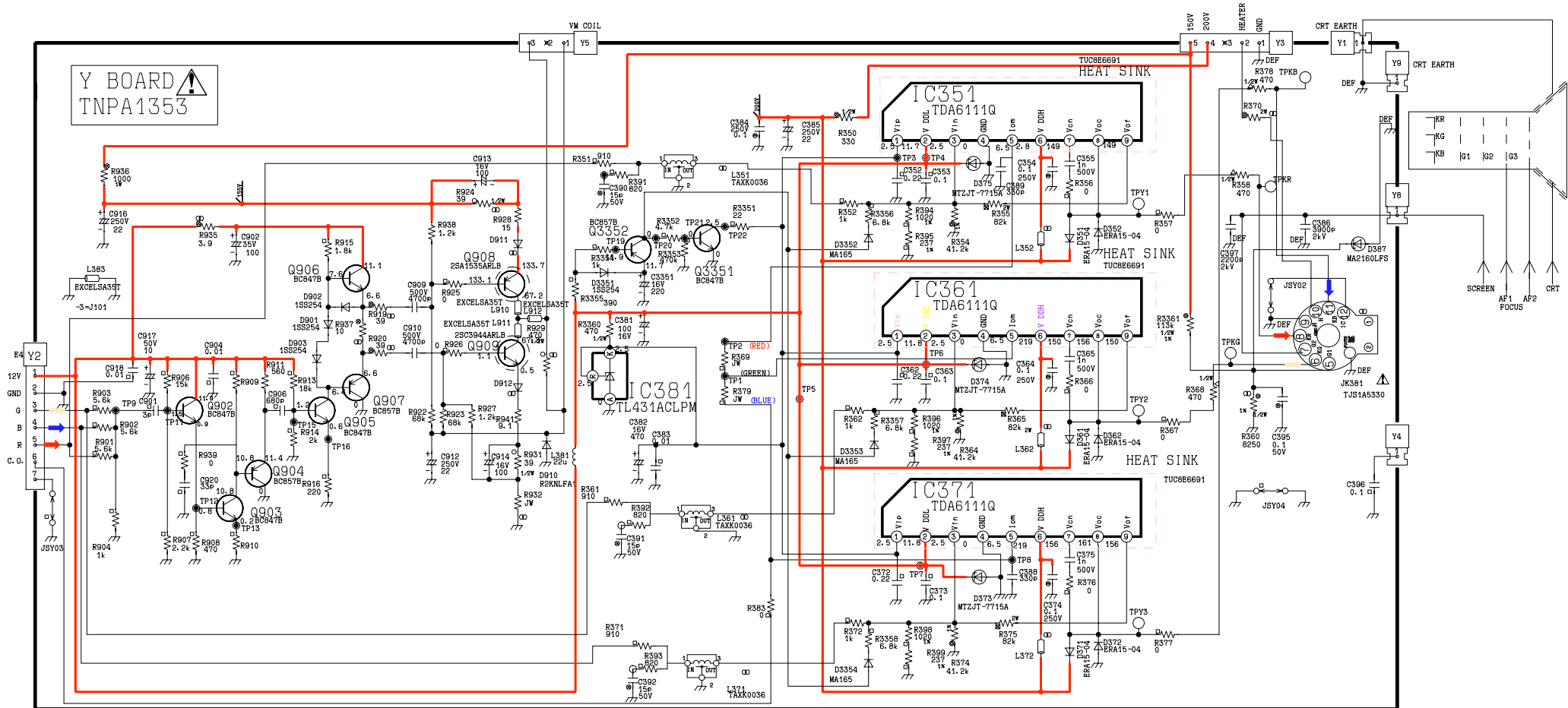



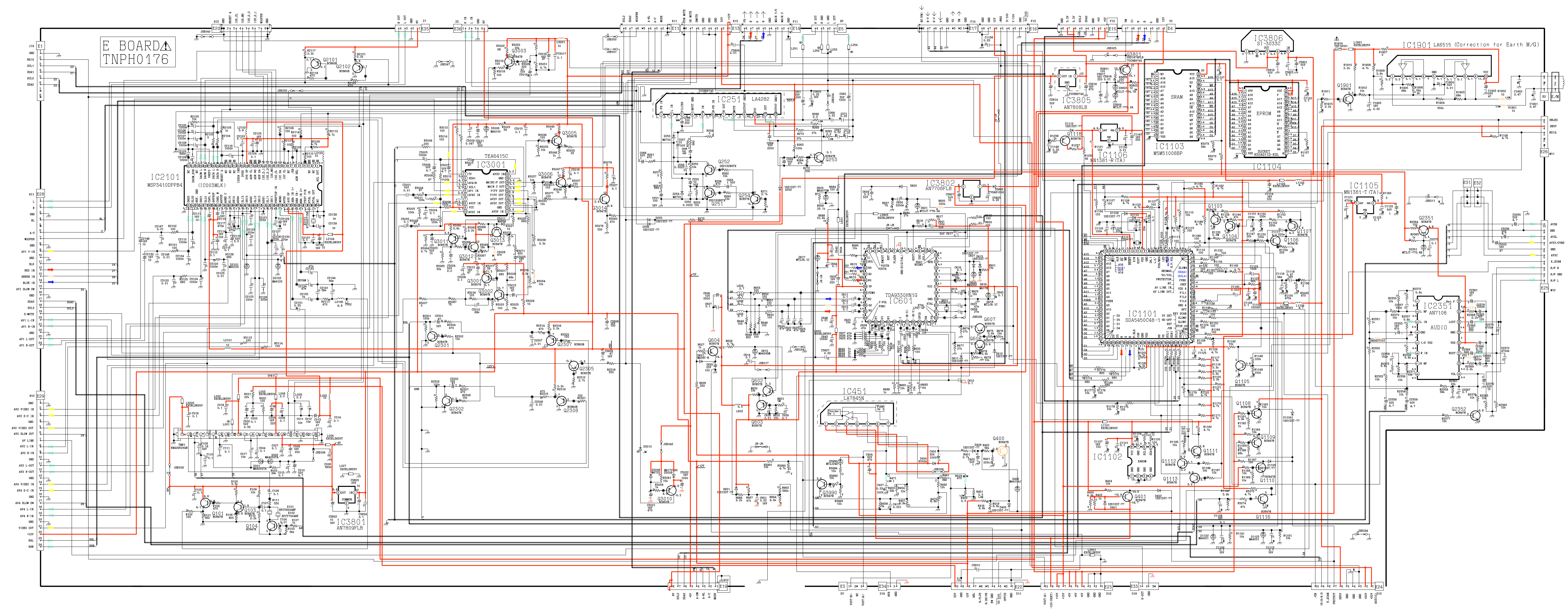

E BOARD  
TNP0176

IC2101  
MSP3410PPB4  
(IC003MLK)

TEA6415C  
IC3001

IC251  
LA4282

IC3805  
AN7808LB

IC3802  
AN7805FLB

IC1103  
M5M5100BBP

IC1106  
MN1381-R(TA)

IC1104  
SDA54504B-1

IC451  
LA7845N

IC1102  
E8A00

IC1105  
MN1381-T(TA)

IC2351  
AN7108  
AUDIO

IC3806  
SI-3033C

IC1901  
LA6515 (Correction for Earth M/G)

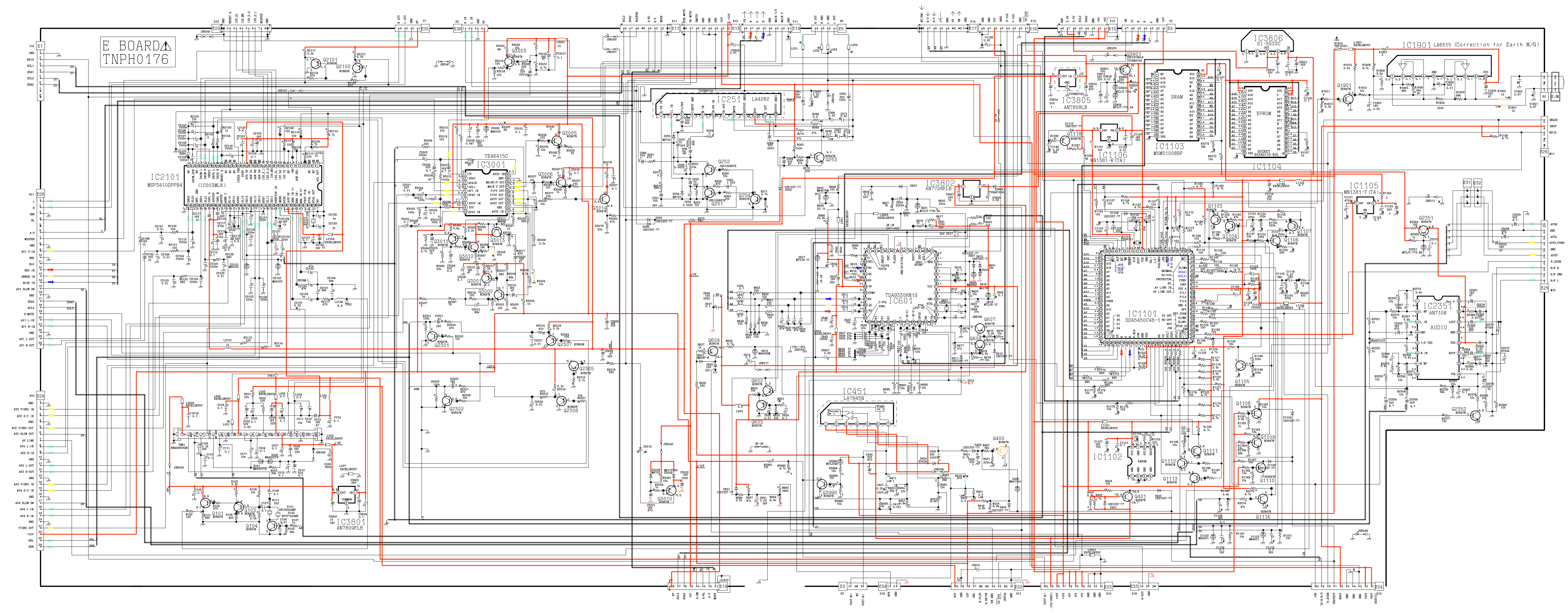

E BOARD  
TNP0176

IC2101  
MSP3410PPB4  
(IC003MLK)

TEA6415C  
IC3001

IC251  
LA4282

IC3805  
AN7808LB

IC3802  
AN7805FLB

IC1103  
M5M5100BBP

IC1106  
MN1381-R(TA)

IC451  
LA7845N

IC1102  
E8A00

IC1105  
MN1381-T(TA)

IC2351  
AN7108  
AUDIO

IC3806  
SI-3033C

IC1901  
LA6515 (Correction for Earth M/G)

V BOARD  
TNP8EV004



V1

⊕  
N5

1

2

3

4

5

6

7

8

D1011  
LNB1RPH





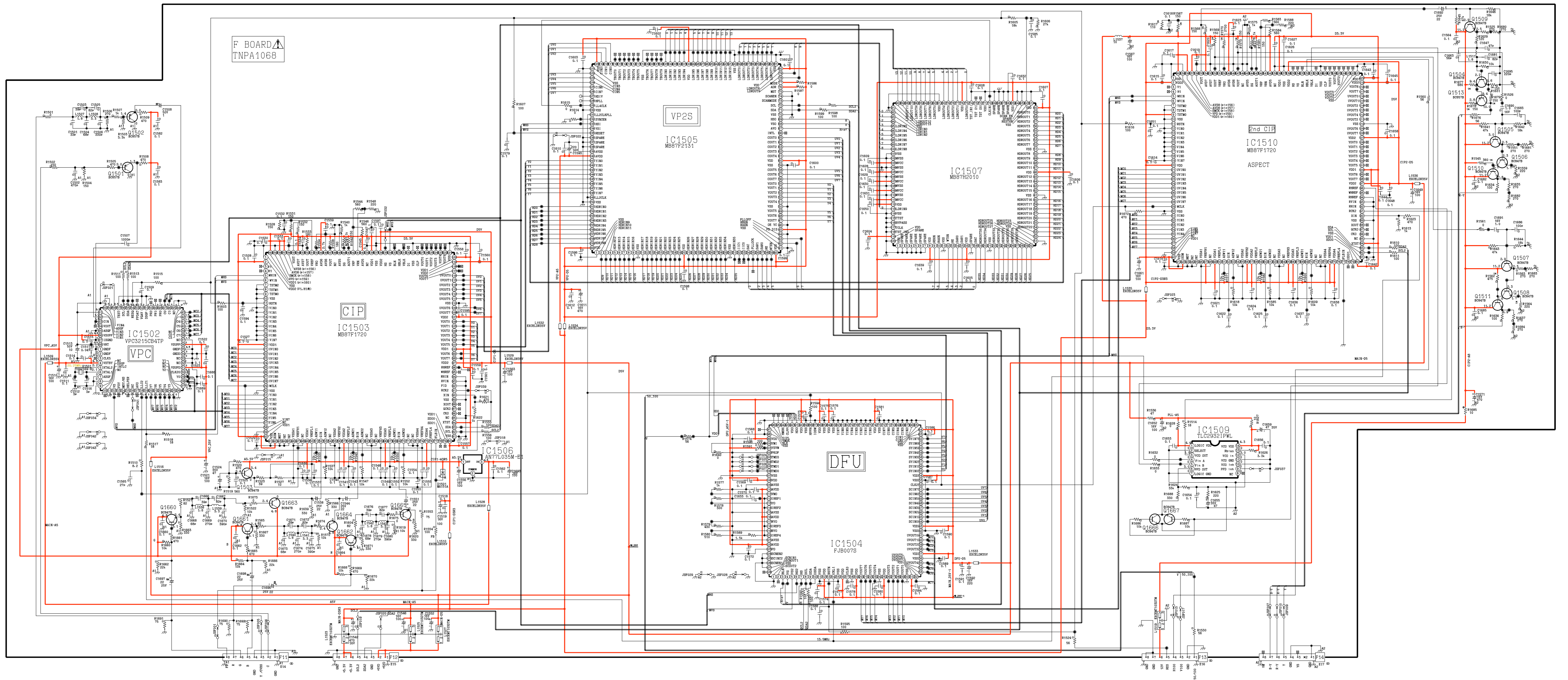

F BOARD  
TNPA1068

VP2S  
IC1505  
MB87F2134

IC1507  
MB87H2010

2nd CIP  
IC1510  
MB87F1720  
ASPECT

CIP  
IC1503  
MB87F1720

VPC  
IC1502  
VPC3215CB4TP

DFU  
IC1504  
FJ5007S

IC1509  
ILC29321PWL

IC1506  
AN77L035M-E1

Q1509  
BC847B

Q1510  
BC847B

Q1506  
BC847B

Q1507  
BC847B

Q1508  
BC847B

Q1666  
BC847B

Q1501  
BC847B

Q1502  
BC847B

Q1660  
BC847B

Q1661  
BC847B

Q1662  
BC847B

Q1503  
BC847B

Q1504  
BC847B

Q1505  
BC847B

Q1506  
BC847B

Q1507  
BC847B

Q1508  
BC847B

Q1509  
BC847B

Q1510  
BC847B

Q1511  
BC847B

Q1512  
BC847B

Q1513  
BC847B

Q1514  
BC847B

Q1515  
BC847B

Q1516  
BC847B

Q1517  
BC847B

Q1518  
BC847B

Q1519  
BC847B

Q1520  
BC847B

Q1521  
BC847B

Q1522  
BC847B

Q1523  
BC847B

Q1524  
BC847B

Q1525  
BC847B

Q1526  
BC847B

Q1527  
BC847B

Q1528  
BC847B

Q1529  
BC847B

Q1530  
BC847B

Q1531  
BC847B

Q1532  
BC847B

Q1533  
BC847B

Q1534  
BC847B

Q1535  
BC847B

Q1536  
BC847B

Q1537  
BC847B

Q1538  
BC847B

Q1539  
BC847B

Q1540  
BC847B

Q1541  
BC847B

Q1542  
BC847B

Q1543  
BC847B

Q1544  
BC847B

Q1545  
BC847B

Q1546  
BC847B

Q1547  
BC847B

Q1548  
BC847B

Q1549  
BC847B

Q1550  
BC847B

Q1551  
BC847B

Q1552  
BC847B

Q1553  
BC847B

Q1554  
BC847B

Q1555  
BC847B

Q1556  
BC847B

Q1557  
BC847B

Q1558  
BC847B

Q1559  
BC847B

Q1560  
BC847B

Q1561  
BC847B

Q1562  
BC847B

Q1563  
BC847B

Q1564  
BC847B

Q1565  
BC847B

Q1566  
BC847B

Q1567  
BC847B

Q1568  
BC847B

Q1569  
BC847B

Q1570  
BC847B

Q1571  
BC847B

Q1572  
BC847B

Q1573  
BC847B

Q1574  
BC847B

Q1575  
BC847B

Q1576  
BC847B

Q1577  
BC847B

Q1578  
BC847B

Q1579  
BC847B

Q1580  
BC847B

Q1581  
BC847B

Q1582  
BC847B

Q1583  
BC847B

Q1584  
BC847B

Q1585  
BC847B

Q1586  
BC847B

Q1587  
BC847B

Q1588  
BC847B

Q1589  
BC847B

Q1590  
BC847B

Q1591  
BC847B

Q1592  
BC847B

Q1593  
BC847B

Q1594  
BC847B

Q1595  
BC847B

Q1596  
BC847B

Q1597  
BC847B

Q1598  
BC847B

Q1599  
BC847B

Q1600  
BC847B

Q1601  
BC847B

Q1602  
BC847B

Q1603  
BC847B

Q1604  
BC847B

Q1605  
BC847B

Q1606  
BC847B



CONDUCTOR VIEWS

ANSICHT DER LEITERBAHNEN

E - BOARD TNPH0176

TRAN'S		DIODE'S			
Q101	A3	D001	A1	D2364	A6
Q103	A3	D002	A1	D3005	B1
Q104	A3	D252	E5	D3006	B2
Q251	D4	D253	E5	D3008	B4
Q252	D4	D254	E5	D3009	A3
Q253	E4	D255	E4	D3010	A3
Q254	E4	D256	E4	D3011	B1
Q281	E3	D281	E4	D3803	A5
Q282	D3	D282	E4	D3804	A5
Q400	B5	D283	E4	D3805	C5
Q401	A4	D284	E2	D3990	A4
Q601	B5	D285	E3		
Q602	B4	D286	E2		
Q603	C4	D400	B5	I.C.'S	
Q604	C4	D401	A4	IC251	E4
Q607	C4	D402	A4	IC281	E2
Q608	D4	D403	B4	IC451	C4
Q1001	C7	D404	A4	IC1001	C7
Q1105	C6	D405	A6	IC1101	D5
Q1106	C6	D408	B5	IC1102	E5
Q1107	C6	D411	A4	IC1103	E5
Q1108	A5	D601	B4	IC1104	D5
Q1109	A5	D603	D5	IC1105	B6
Q1110	A5	D605	B5	IC1106	D6
Q1111	C5	D607	B5	IC1901	C6
Q1112	E5	D609	B5	IC2101	B3
Q1113	E5	D610	C4	IC2351	A6
Q1114	C6	D611	C4	IC3001	B1
Q1116	C6	D612	C4	IC3801	A2
Q1118	D6	D615	B5	IC3802	C5
Q1901	C6	D616	B5	IC3805	B5
Q2101	B2	D617	D5	IC3806	D1
Q2102	C2	D618	C4		
Q2103	B2	D620	B5	T.P.'S	
Q2301	B2	D651	C4	TPE1	A2
Q2302	A2	D652	C4	TPE2	B3
Q2305	A2	D653	B4	TPE23	D6
Q2307	A3	D1001	C7		
Q2308	A3	D1101	C1		
Q2351	A6	D1102	C1		
Q2352	A6	D1103	C1		
Q3001	C1	D1104	A6		
Q3002	B1	D1105	A6		
Q3003	B2	D1106	B6		
Q3005	D1	D1107	C5		
Q3006	D1	D1108	C6		
Q3007	D1	D1109	D6		
Q3008	D1	D1110	D6		
Q3010	A3	D1111	D6		
Q3011	B2	D1112	D6		
Q3012	B2	D2101	B2		
Q3013	B2	D2102	B2		
Q3014	D1	D2301	A2		
Q3801	A5	D2302	A2		
Q3990	A4	D2351	A6		

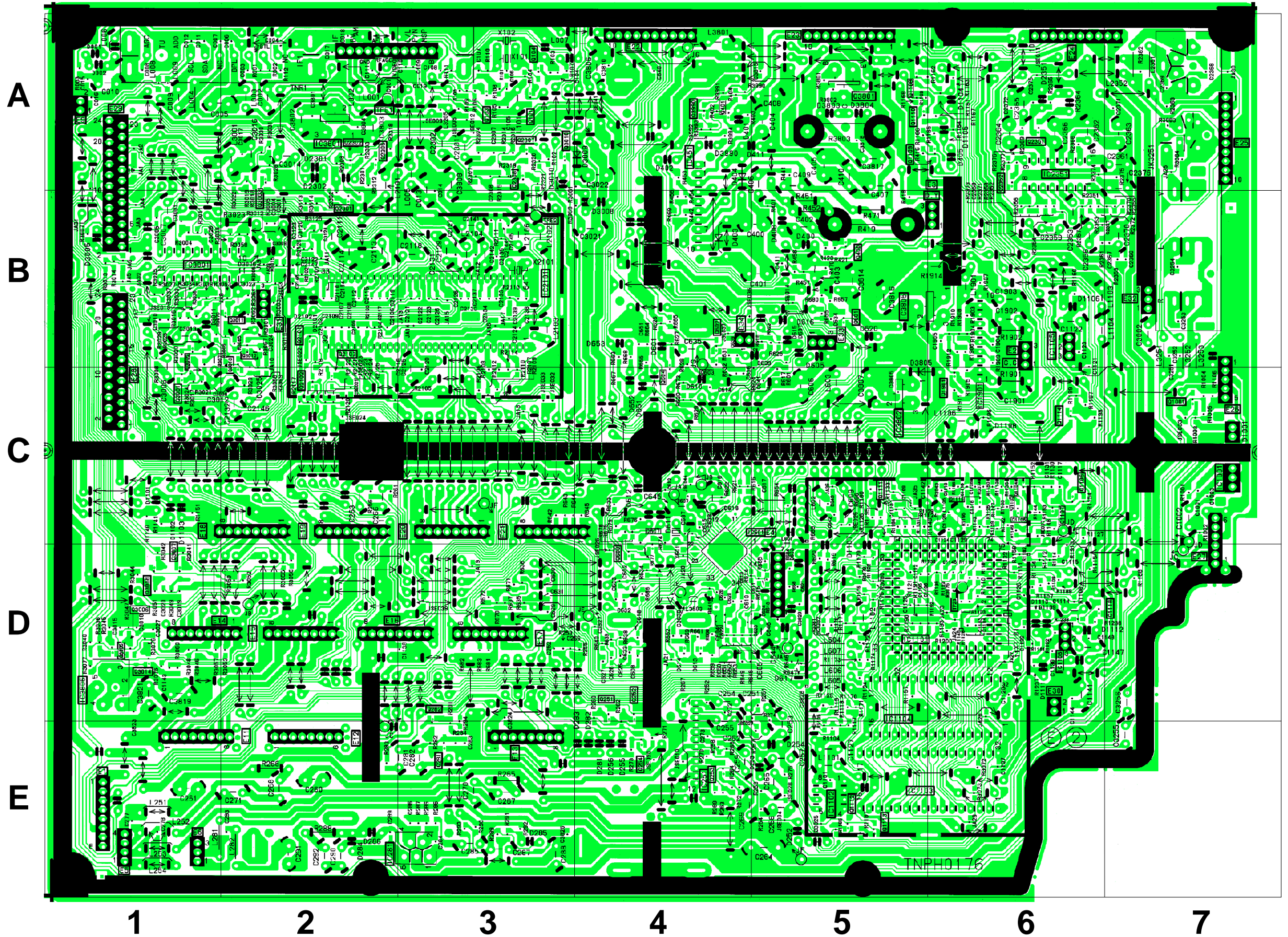



# Y - BOARD TNPA1353

TRAN'S	
Q901	C1
Q902	B1
Q903	B1
Q904	C1
Q906	C1
Q908	D1
Q909	D1
Q3351	A2
Q3352	A2
DIODE'S	
D351	B3
D352	B3
D361	A2
D362	A2
D371	C3
D372	C2
D373	C3
D374	A1
D375	B2
D387	B1
D901	C1
D902	C1
D903	C1
D910	C1
D911	D2
D3351	A2
D3352	A3
D3353	A1
D3354	C3
T.P.'S	
TPY1	B3
TPY2	A2
TPY3	C2
TPKR	B3
TPKB	B2
TPKB	C2
I.C.'S	
IC351	B2
IC361	A1
IC371	C3
IC381	C3

**A**  
**B**  
**C**  
**D**

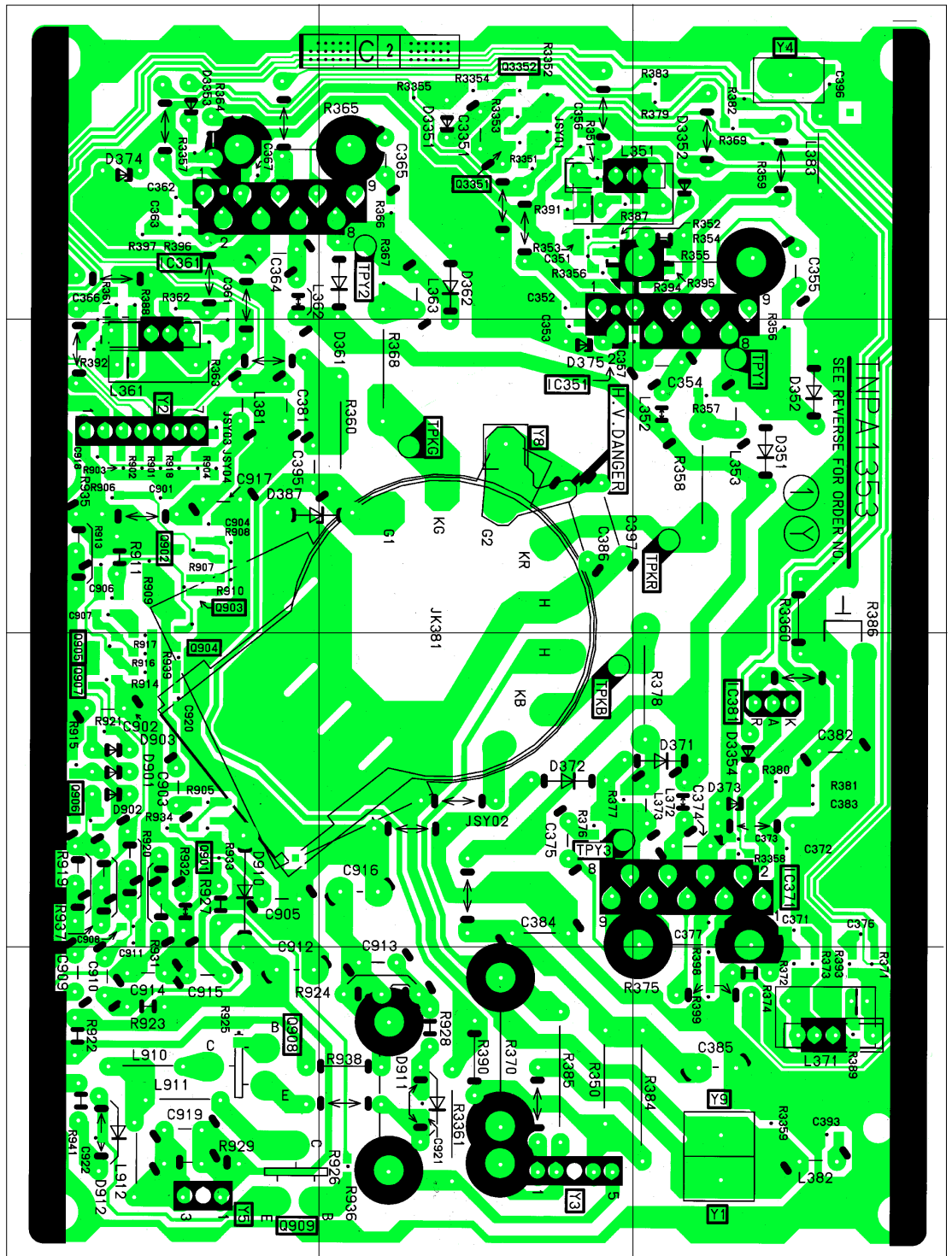

**1**                      **2**                      **3**

D - BOARD TNPA0876

DIODE'S		TRAN'S	
D502	B4	Q502	B4
D503	B3	Q552	A3
D504	B3	Q553	A1
D505	E5	Q554	A1
D551	A4	Q701	E4
D556	D2	Q801	A5
D559	E3	Q803	A4
D560	A1	Q804	A4
D561	B2	Q845	E7
D563	A3	Q846	C7
D565	A1	Q847	E7
D566	A1	Q848	D7
D571	A2	Q849	E5
D575	A1	Q850	E5
D591	C1	Q852	E7
D592	D1	Q853	B4
D701	D4	Q854	C4
D806	A6	Q3901	E1
D807	A7	Q3902	D1
D808	A4	Q3903	E1
D809	A4	Q3904	D1
D810	A5	Q3905	D2
D812	A4	Q3906	E2
D813	A4	Q3907	E2
D814	B4	Q3908	E2
D815	B4	Q3911	D2
D817	B7	Q3912	E2
D818	A5	Q3916	E1
D819	A4		
D820	B4	<b>T.P.'S</b>	
D821	B4	TPDG1	A1
D845	C7	TPDG2	B1
D846	E7	TPD11	D1
D847	D7	TPD12	E1
D848	D6	TPD13	D1
D849	D6	TPD14	D2
D851	D4	TPD15	E2
D852	C4		
D853	E6	<b>I.C.'S</b>	
D854	D7	IC801	A4
D855	D6	IC845	C4
D856	E7	IC852	E6
D857	E6	IC3901	E1
D858	E5		
D860	E5		
D861	E7		
D3901	D1		
D3907	E2		
D3908	D2		
D3909	E2		
D3910	D3		
D3911	C2		
D3912	E3		
D3915	E2		
D3917	D1		
D3918	E2		

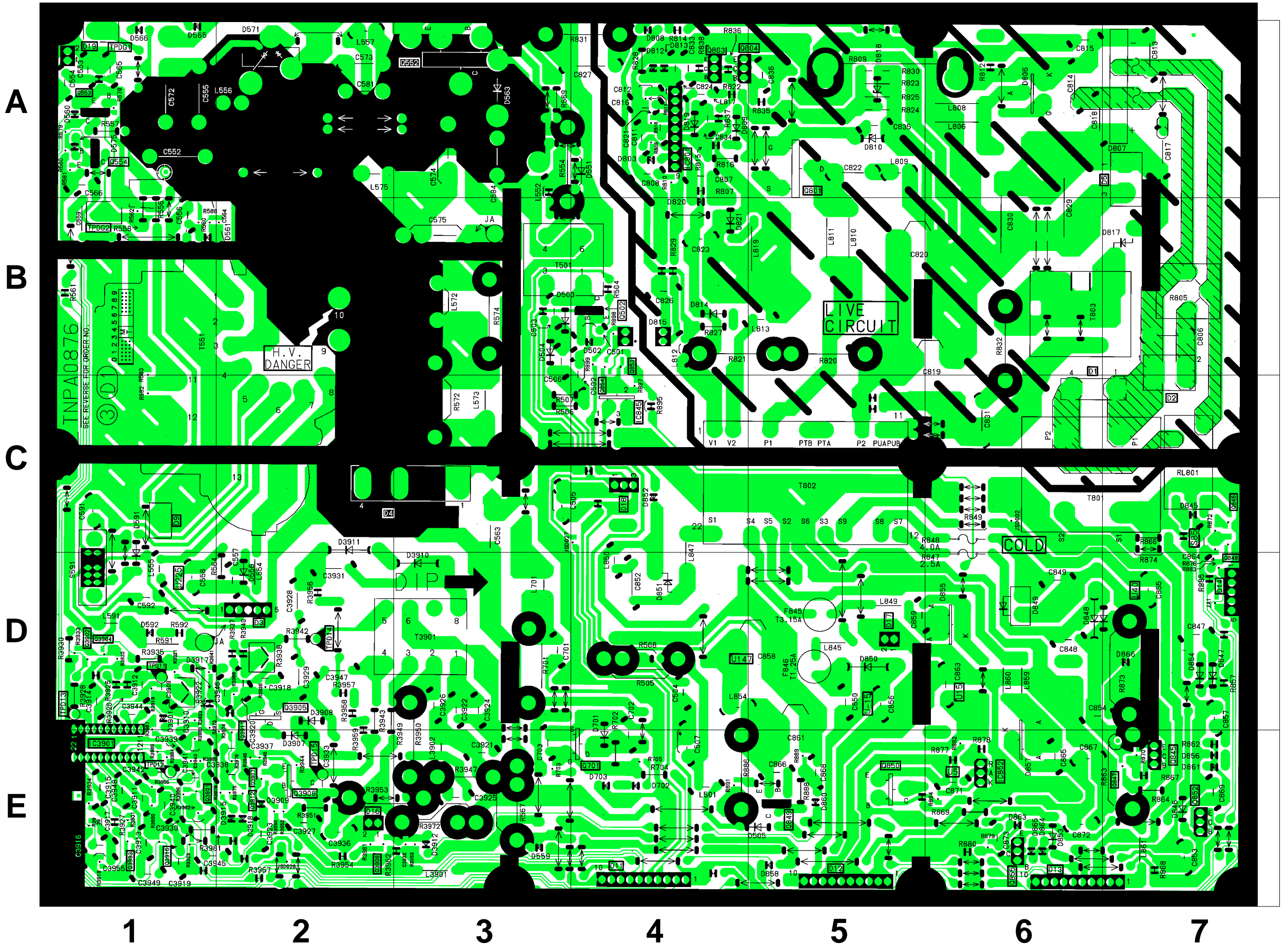

# H - BOARD TNPA1047

TRAN'S	
Q2401	A2
Q2407	A3
Q2408	A3
Q2409	A3
Q2410	A3
Q2411	A3
Q2412	A3
Q3401	B1
Q3402	C1
Q3403	B1
Q3404	C1
Q3405	C3
Q3406	C3

DIODE'S	
D2401	A2
D2403	A3
D2404	A3
D2405	A3
D2406	A3
D2407	A3
D2408	A3
D3401	C3
D3402	C3

T.P.'S	
TPH1	D1
TPH2	A2
TPH3	D1
TPH004	D1
TPH005	D1

I.C.'S	
IC2401	A2
IC2402	A3

**A**

**B**

**C**

**D**

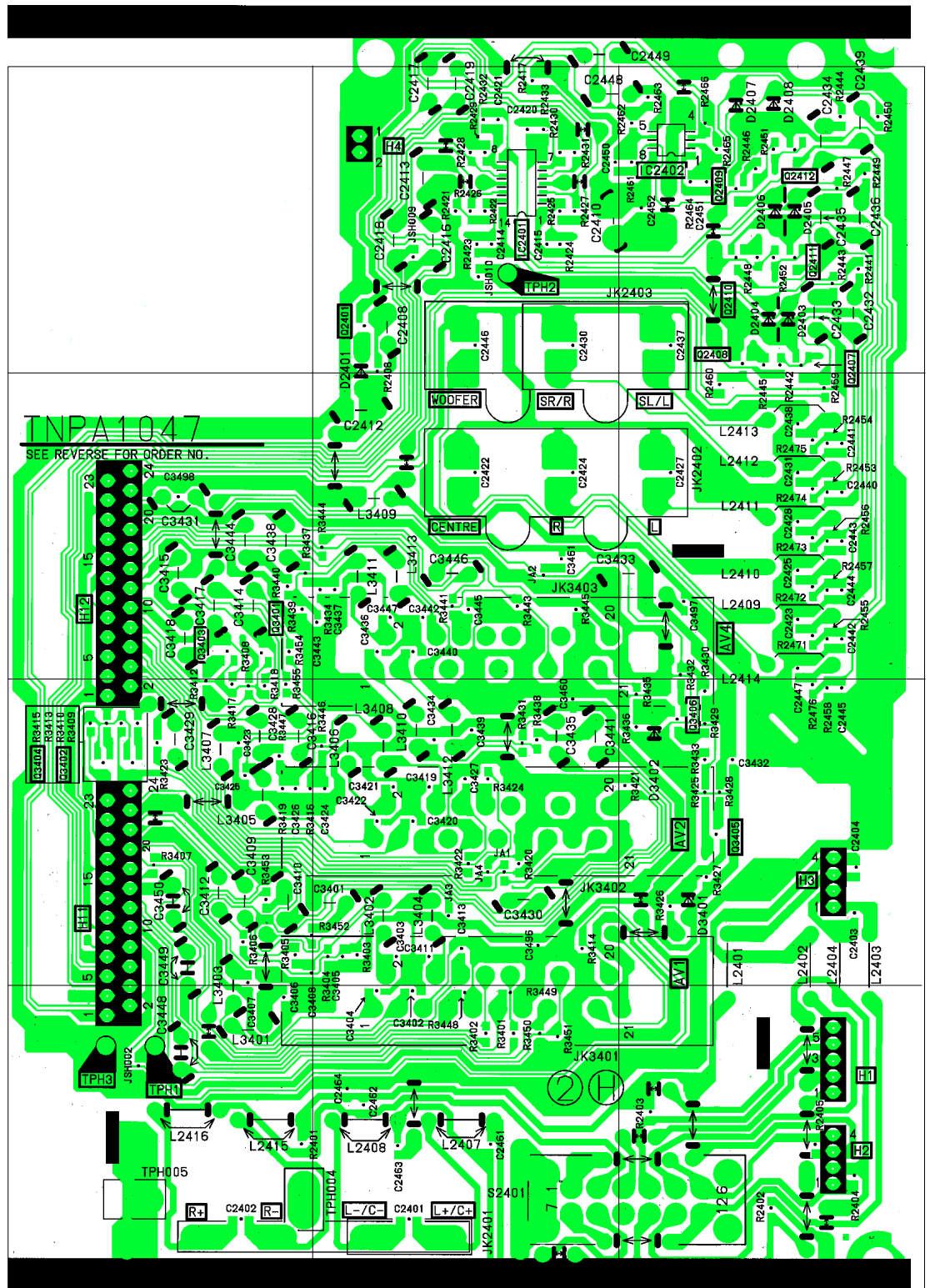

1

2

3



# F - BOARD TNPA1068

TRAN'S	
Q1663	B2
Q1664	B2
Q1665	B2
Q1666	C1
Q1667	C1

I.C.'S	
IC1502	B3
IC1503	C3
IC1504	D1
IC1505	D2
IC1506	C2
IC1509	C1
IC1510	C1

**A**

**B**

**C**

**D**

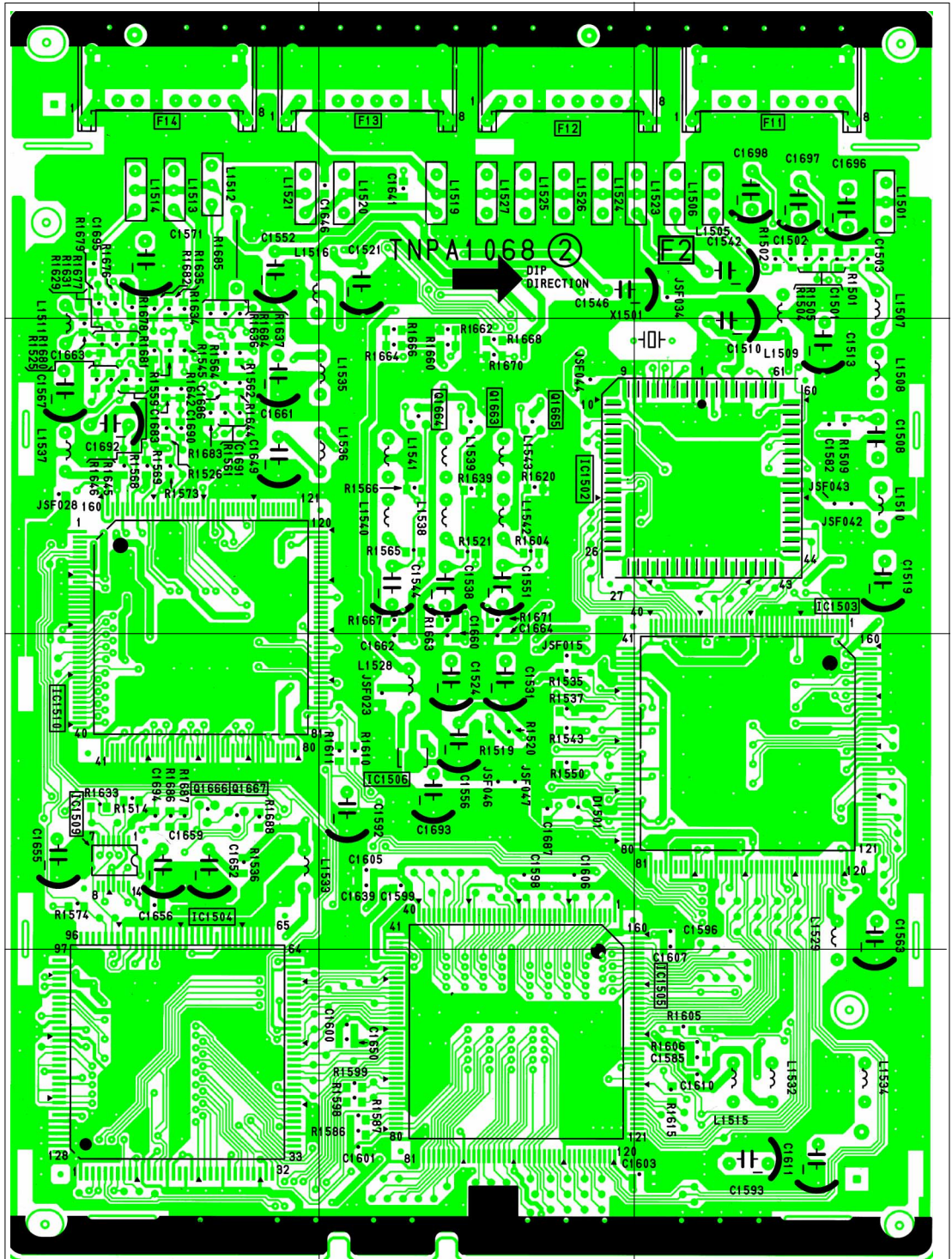

**1**

**2**

**3**

# F - BOARD TNPA1068

TRAN'S	
Q1501	D3
Q1502	C3
Q1503	B2
Q1504	C1
Q1505	C1
Q1506	C1
Q1507	C1
Q1508	C1
Q1509	C1
Q1510	D1
Q1511	D1
Q1519	D1
Q1660	C2
Q1661	C2
Q1662	C2
I.C.'S	
IC1507	B2

**A**

**B**

**C**

**D**

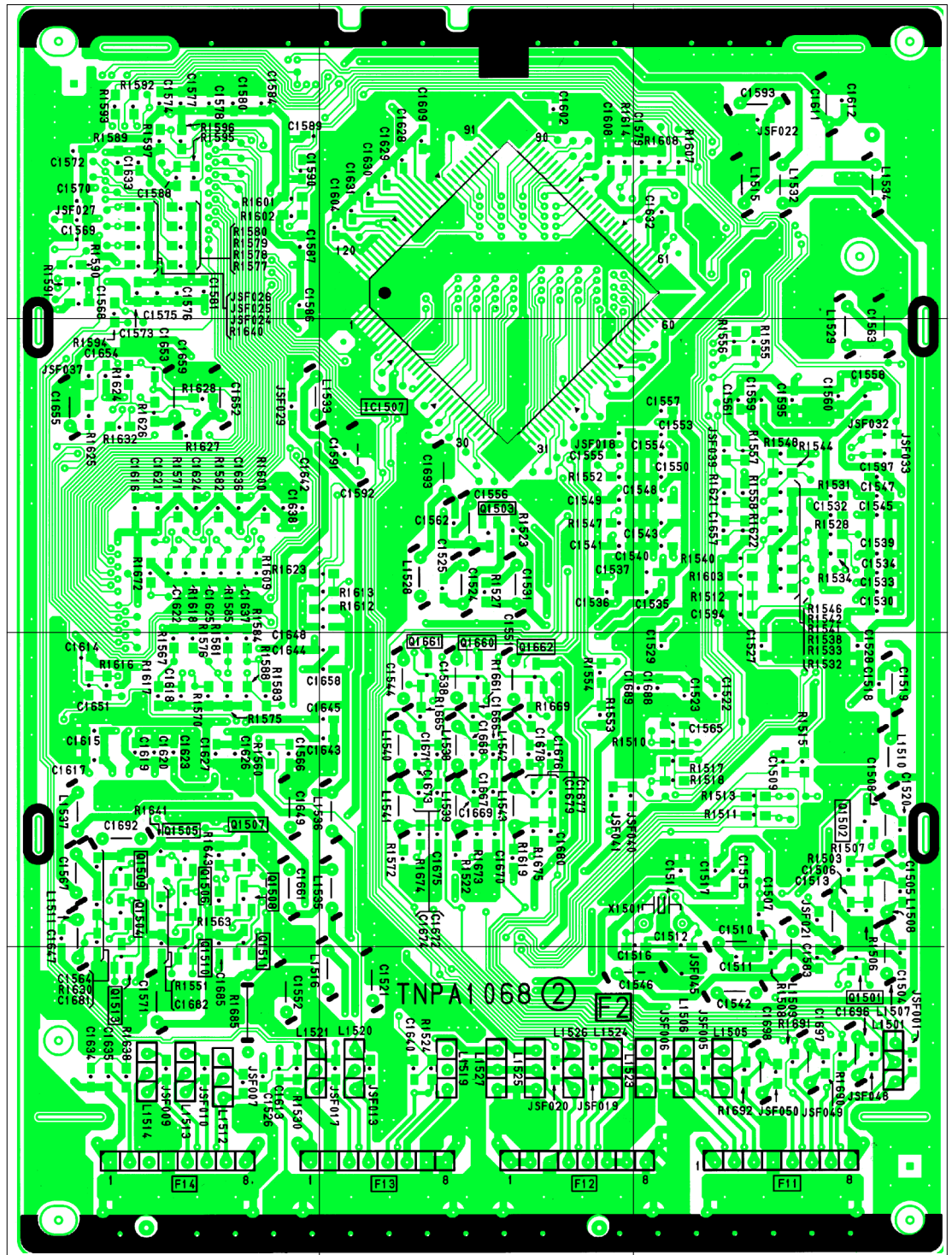

**1**

**2**

**3**





# Z - BOARD TNP8EZ001

TRAN'S	
Q2201	C1
Q2202	B1
Q2203	C2
Q2204	A2
T.P.'s	
TPZ1	C1
TPZ2	C1
TPZ3	A2
I.C.'S	
IC2201	B1
IC2221	A1
DIODE'S	
D2201	A2

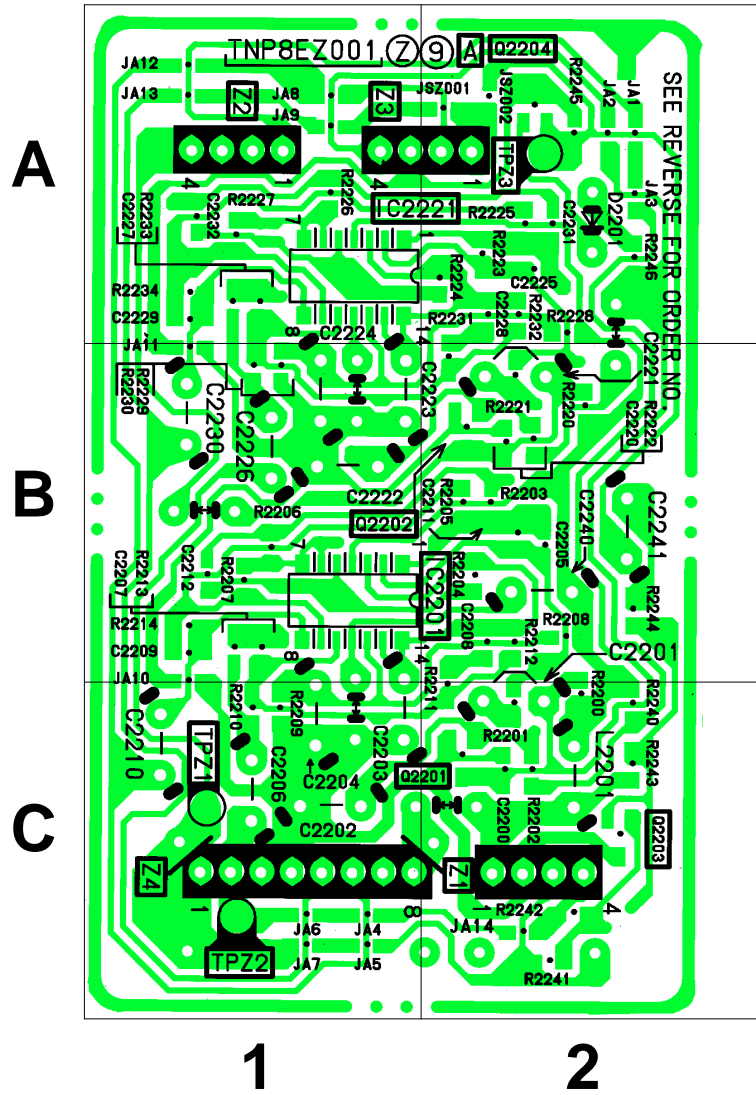



# M - BOARD TNP8EM019

DIODE'S	
D1012	A1
D1013	A1
D1014	A1
D1015	A1
D1016	A1
D1017	A1

**A**

**B**

**C**

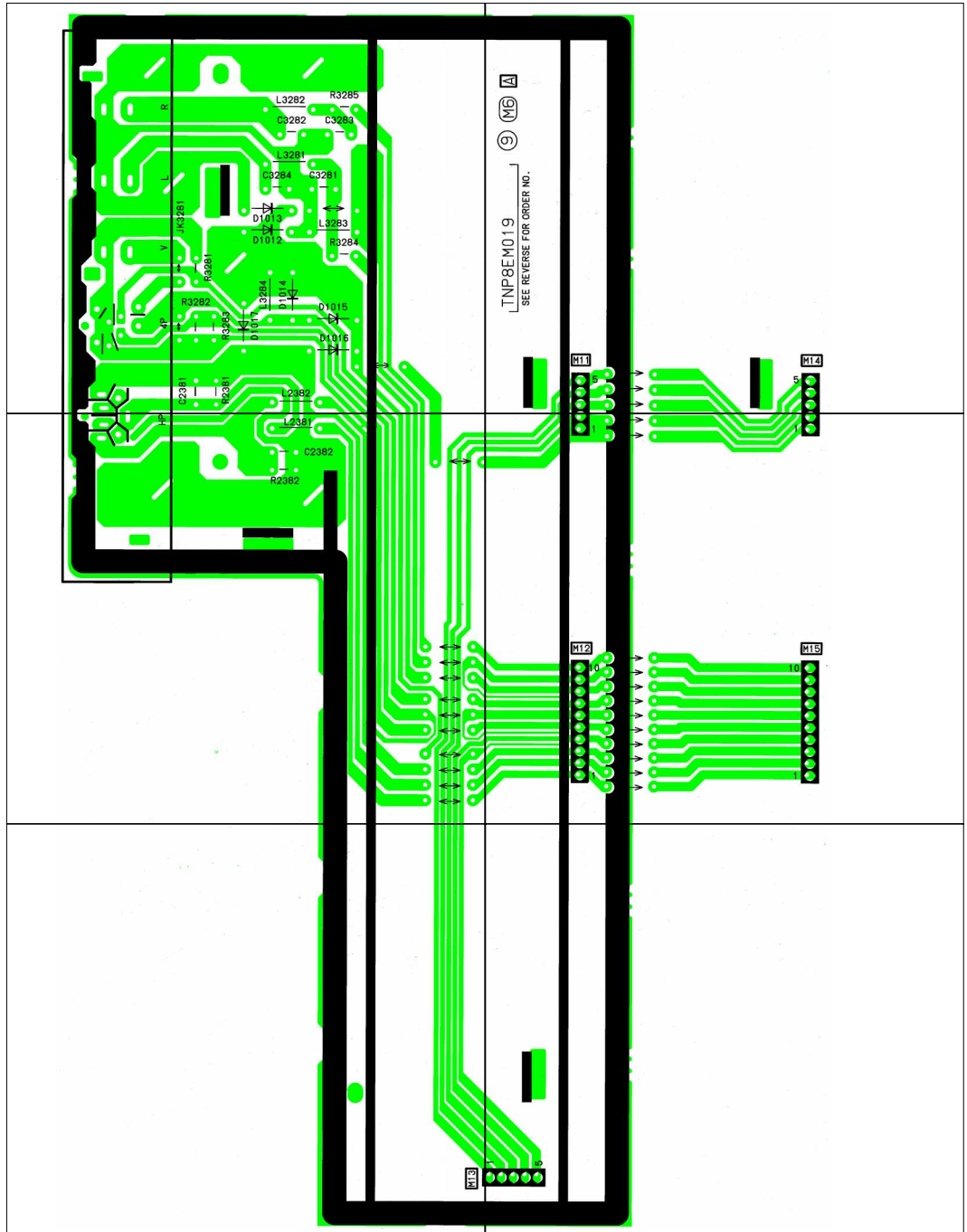

**1**

**2**

# V - BOARD TNP8EV004

DIODES	
D1011	A4

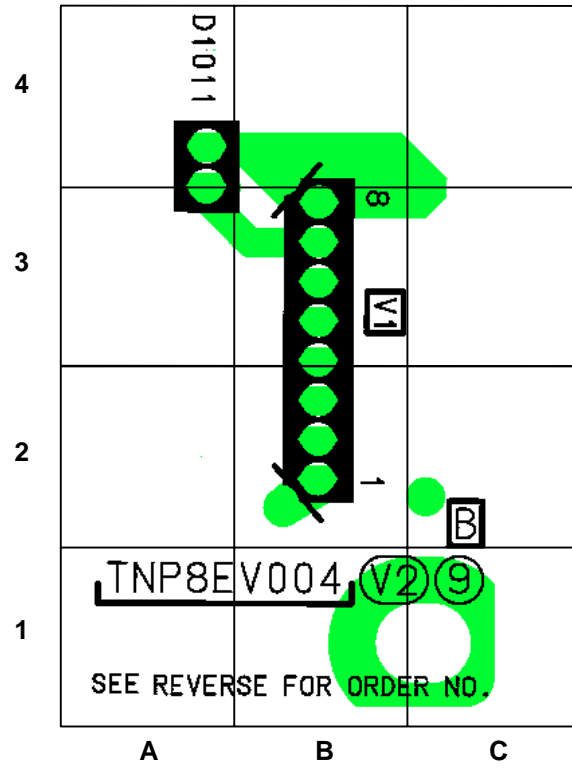

Q - BOARD TNP8EQ002

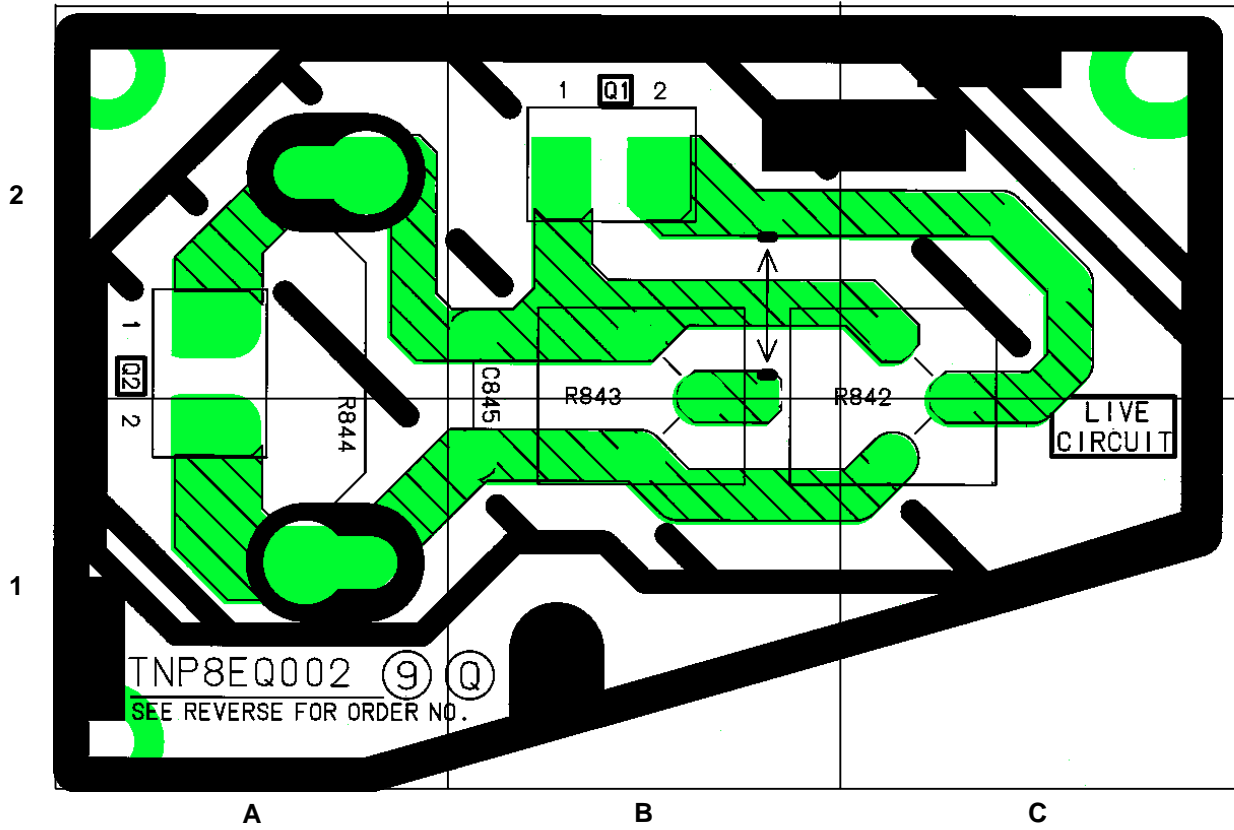

# G - BOARD TNPA0877

TRAN'S	
Q1801	C2
Q1802	C3
Q1803	C3
Q1804	B2
Q1805	B3
Q1806	B3
Q2502	A2
Q2505	A2
Q2506	B2
Q2507	A2
I.C.'S	
IC1801	C2
IC1802	C1
IC2501	A2
DIODE'S	
D1801	B2
D1802	B2

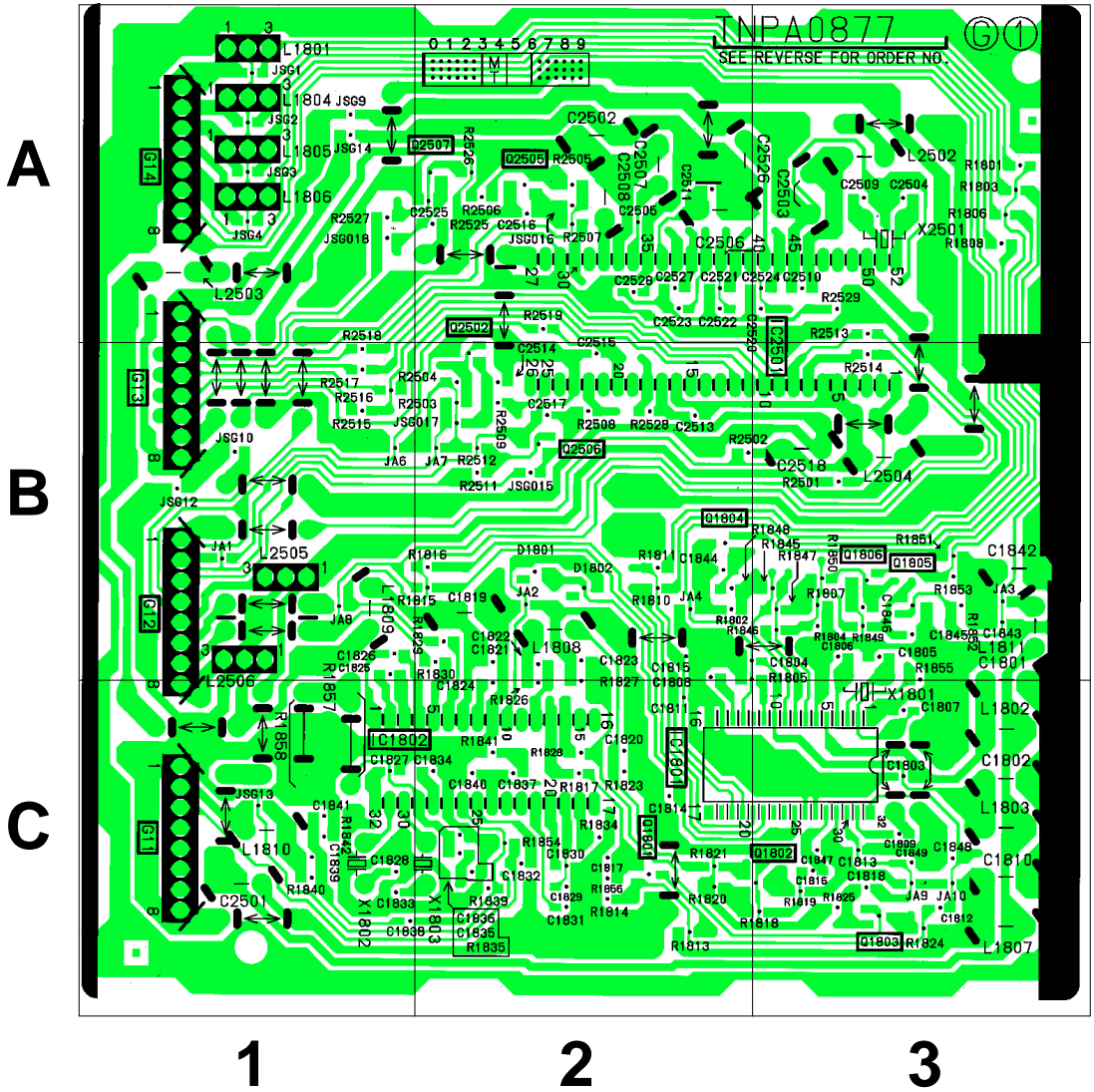

K - BOARD TNPA1046

DIODE'S	T.P.'S
D2551	A4 TPK001 E4
D2552	B1 TPK002 E6
D2553	A2 TPK4 D5
D2554	A2 TPK5 D3
D2555	A1 TPK6 D3
D2556	B2 TPK7 A6
D2558	C2 TPK8 C7
D2559	D1 TPK9 B4
D2605	D6 TPK10 E1
D2610	C5 TPK11 E1
D2611	C7 TPK12 D7
D2615	C6 TPK13 C6
D2616	B6 TPK14 D7
D2619	B6 TPK15 D7
D2620	B6 TPK16 D7
D2621	B6 TPK17 D2
D2622	B6 TPK18 D2
D2623	B6 TPK19 D4
D2630	D5 TPK20 D5
D2631	D6 TPK21 D5
D2640	D5 TPK22 D5
D2641	D4
D2650	C3
D2651	D3
D2660	D3
D2661	D3
D2670	A6
D2671	A6
D2672	B6
D2680	D6
<b>TRAN'S</b>	
D2651	D3 Q2554 C3
D2660	D3 Q2555 C3
D2661	D3 Q2605 D6
D2670	A6 Q2610 C6
D2671	A6 Q2611 C6
D2672	B6 Q2615 B6
D2680	D6 Q2616 C6
<b>I.C.'S</b>	
IC2551	A2 Q2621 B6
IC2630	C5
IC2640	D5
IC2650	C3
IC2660	D3
IC2670	A6

